

# CABLES AND SENSORS

## COMPATIBLE PATIENT MONITOR ACCESSORIES CATALOG

SpO2, ECG, EKG, NIBP, IBP, Temperature, Ultrasound and O2

- **Ships today:** Same-day shipping on thousands of parts!
- **Low-price guarantee:** We'll beat any competitive price – guaranteed.
- **Buy from experts:** We know patient monitor accessories like no one else.

866-373-6767 • [www.CablesandSensors.com](http://www.CablesandSensors.com)



# Table of Contents

<b>SpO2</b> Probes & Adapters	7
<b>ECG</b> Cables & Leadwires (3 or 5 leads)	51
<b>EKG</b> Patient Cables & Leadwires (10 leads)	75
<b>NIBP</b> Hoses, Cuffs & Connectors	86
<b>IBP</b> Adapters, Converters & Disposable Transducers	98
<b>Temperature</b> Probes	109
<b>Ultrasound</b> Transducers & Repair Cables	116
<b>O<sub>2</sub> Cells</b> for Respiratory Applications	120
<b>Warranty Information</b>	131



**Direct Connect Sensors**  
9 foot cable

A small image showing a white cable with a gold-plated connector on the left and a white plastic sensor housing on the right.

**Short Sensors**  
3 foot cable

A small image showing a white cable with a gold-plated connector on the left and a white plastic sensor housing on the right.

# SpO2

Compatible SpO2 probes, adapters and accessories

**Disposable Sensors**  
3 foot cable

A small image showing a white cable with a gold-plated connector on the left and a disposable sensor strip on the right.

**Adapter Cables**  
1, 4, 7, 8, 10 or 12 feet

A small image showing a blue cable with a gold-plated connector on the left and a white plastic sensor housing on the right.

**SpO2 Accessories**

A small image showing a black plastic accessory, possibly a clip or a connector.



# Choosing your SpO2 probe



## Adult Clip

Best for a secure grab and for short-term, spot-checking.  
Patient size: >85lbs



## Adult Soft

Best for patient comfort and long-term care.  
Patient size >85lbs



## Pediatric Clip

Stronger hold for the little ones that like to move.  
Patient size: 30 – 85lbs



## Pediatric Soft

A more gentle grab for longer-term monitoring.  
Patient size: 30 – 85lbs



## Infant Soft

A gentle option for the smaller ones. Patient size: 6 – 30lbs.  
Select models only.



## Neonate Wrap

Gentle foot wrap for newborns.  
Patient size: 2 – 7lbs



## Multi-Site

A versatile option for all patient sizes. Apply on foot, finger or ear lobe (with attachment).



## Adult Ear Clip

Best choice for patients with low perfusion or burns.  
Select models only.



## Adult Finger Wrap

An alternative option for adult finger application.  
Select models only.

### BCI Direct Connect Sensors

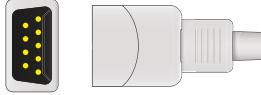
Models	Connector	Options	Part Number	OEM #	Price
3180, 3300, 3404, 3444, 6100, 9100, Advisor, Autocorr, Mini Torr, Mini Torr Plus; Larsen & Toubro Limited (L&T Medical) Stellar P, Star 50, Galaxy, Planet, Planet 50, Cosmic		Adult Clip	<b>S410-760</b>		<b>\$112</b>
		Adult Soft	<b>S410S-760</b>		<b>\$112</b>
		Pediatric Clip	<b>S103-760</b>		<b>\$112</b>
		Pediatric Soft	<b>S103S-760</b>		<b>\$112</b>
		Neonate Wrap	<b>S310-760</b>		<b>\$126</b>
		Multi-Site	<b>S810-760</b>		<b>\$126</b>
3300, 3301, 3302, 3303, 3304, 3400, 3401, 3403, 9200; Spacelabs Burdick: PRO2; Drager: Oxipac 2000; MMedChoice: MD300A; Invacare 3300nv		Adult Clip	<b>S410-060</b>		<b>\$112</b>
		Adult Soft	<b>S410S-060</b>		<b>\$112</b>
		Pediatric Clip	<b>S110-060</b>		<b>\$112</b>
		Pediatric Soft	<b>S110S-060</b>		<b>\$112</b>
		Neonate Wrap	<b>S310-060</b>		<b>\$126</b>
		Multi-Site	<b>S810-060</b>		<b>\$126</b>



### BCI Short Sensors

Models	Connector	Options	Part Number	OEM #	Price
3180, 3401, 3304, 3303, 3302, 3301, 3300, 3400, 3403, Smiths Medical BCI Capnocheck 9004, Spectro 2   10, 20, 30, SurgiVet; Spacelabs Burdick: PRO2; Drager: Drager Oxipac 2000; Armstrong Medical AD-1000; Beijing Choice Electronic: Pulse Oximeter model MD30011		Adult Clip	<b>S403-060</b>	3444	<b>\$110</b>
		Adult Soft	<b>S403S-060</b>		<b>\$110</b>
		Pediatric Clip	<b>S103-060</b>	3178	<b>\$110</b>
		Pediatric Soft	<b>S103S-060</b>		<b>\$110</b>
		Neonate Wrap	<b>S303-060</b>		<b>\$118</b>
		Multi-Site	<b>S8030-060</b>		<b>\$118</b>

### BCI Disposable Sensors

Models	Connector	Options	Part Number	OEM #	Price
		Adult Box of 24	<b>S503-060</b>	1300	<b>\$240</b>
		Pediatric Box of 24	<b>S523-060</b>	1301	<b>\$240</b>
		Infant Box of 24	<b>S533-060</b>	1303	<b>\$240</b>
		Neonate Box of 24	<b>S543-060</b>	1302	<b>\$240</b>



### BCI Adapter Cables

Models	Connector	Options	Part Number	OEM #	Price
6100, 9100, Advisor, Autocorr, Mini Torr and Mini Torr Plus	<p>To Monitor:</p>  <p>To BCI Sensor:</p> 	7 Foot Adapter	<b>E708-760</b>		<b>\$57</b>



**Biolight Direct Connect Sensors**

Models	Connector	Options	Part Number	OEM #	Price
M7000		Adult Clip	<b>S410-68D0</b>		<b>\$126</b>
		Adult Soft	<b>S410S-68D0</b>		<b>\$126</b>
		Pediatric Clip	<b>S110-68D0</b>		<b>\$126</b>
		Pediatric Soft	<b>S110S-68D0</b>		<b>\$126</b>
		Neonate Wrap	<b>S310-68D0</b>		<b>\$126</b>
		Multi-Site	<b>S810-68D0</b>		<b>\$126</b>



**Bionet Direct Connect Sensors**

Models	Connector	Options	Part Number	OEM #	Price
BM3		Adult Clip	<b>S410-580</b>		<b>\$112</b>
		Adult Soft	<b>S410S-580</b>		<b>\$112</b>
		Pediatric Clip	<b>S110-580</b>		<b>\$112</b>
		Pediatric Soft	<b>S110S-580</b>		<b>\$112</b>
		Neonate Wrap	<b>S310-580</b>		<b>\$126</b>
		Multi-Site	<b>S810-580</b>		<b>\$126</b>
BM3		Adult Clip	<b>S410-1080</b>		<b>\$112</b>
		Adult Soft	<b>S410S-1080</b>		<b>\$112</b>
		Pediatric Clip	<b>S110-1080</b>		<b>\$112</b>
		Pediatric Soft	<b>S110S-1080</b>		<b>\$112</b>
		Neonate Wrap	<b>S310-1080</b>		<b>\$126</b>
		Multi-Site	<b>S810-1080</b>		<b>\$126</b>

**Bionet Adapter Cables**

Models	Connector	Options	Part Number	OEM #	Price
BM3, BM3 Plus	<p>To Monitor:</p>  <p>To Nellcor non-Oximax Sensor:</p> 	7 Foot Adapter	<b>E708-580</b>		<b>\$57</b>

## Cardell Adapter Cables



Models	Connector	Options	Part Number	OEM #	Price
Cardell MAX-12 Duo HD and 9500 Series	<p>To Monitor:</p>  <p>To Nellcor Oximax Sensor:</p> 	10 Foot Adapter	<b>E710P-380</b>		<b>\$96</b>

## CAS Med (See Nellcor)

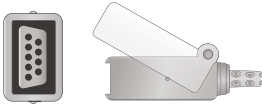
## Corometrics Adapter Cables

Models	Connector	Options	Part Number	OEM #	Price
Corometrics 118, 511 and 556	<p>To Monitor:</p>  <p>To Nellcor non-Oximax Sensor:</p> 	7 Foot Adapter	<b>E708-250</b>	4033CAX	<b>\$72</b>

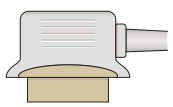
## Criticare Direct Connect Sensors

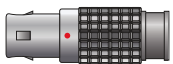
Models	Connector	Options	Part Number	OEM #	Price
Alaris 4415 (IVAC): VitalCheck 4400, 4410; Criticare: 503DX-W, 503S, 503DX, 503 Spot, 504DX/P, 504DX, 506 series (except 506LN3), 507ELC2, 8000 series, 8100 series, Poet Plus, Poet R Plus, Poet (602-3A), Scholar, Scholar III, nGenuity	 	Adult Clip	<b>S410-750</b>	934-10DN	<b>\$112</b>
		Adult Soft	<b>S410S-750</b>	975AD-10	<b>\$112</b>
		Pediatric Clip	<b>S110-750</b>	1563-10D	<b>\$112</b>
		Pediatric Soft	<b>S110S-750</b>	975PD-10	<b>\$112</b>
		Neonate Wrap	<b>S310-750</b>		<b>\$126</b>
		Multi-Site	<b>S810-750</b>		<b>\$126</b>
Scholar, Poet (602-3A), 1100, 2200, 500, 500A 501, 502 series, 503, 504, 504/P, 5040/P, 504US/P, 507, 507E/P/R, 507/S, 507SD, 5070/P, 508, 509, 581	 	Adult Clip	<b>S410-050</b>	934-10LN	<b>\$112</b>
		Adult Soft	<b>S410S-050</b>	975AD-10L	<b>\$112</b>
		Pediatric Clip	<b>S110-050</b>	1563-10L	<b>\$112</b>
		Pediatric Soft	<b>S110S-050</b>	975PD-10L	<b>\$112</b>
		Neonate Wrap	<b>S310-050</b>		<b>\$126</b>
		Multi-Site	<b>S810-050</b>	940-10L	<b>\$126</b>





### Criticare Short Sensors

Models	Connector	Options	Part Number	OEM #	Price
Alaris (IVAC): VitalCheck 4400 511SD; Criticare: 503DX-W, 503S, 503DX, 503 Spot, Mini Spot, 504DX/P, 504DX, 506 series (except 506LN3), 507ELC2, 507EL, 8100 series, Poet Plus, Poet (602-3A), Scholar, Scholar III		Adult clip	<b>S403-750</b>	934SDN	<b>\$110</b>
		Adult soft	<b>S403S-750</b>	975AD-3	<b>\$110</b>
		Pediatric clip	<b>S103-750</b>	1563SD	<b>\$110</b>
		Pediatric soft	<b>S103S-750</b>	975PD-3	<b>\$110</b>
		Neonate Wrap	<b>S303-750</b>	940SD	<b>\$110</b>
		Multi-Site	<b>S803-750</b>		<b>\$110</b>

### Criticare Disposable Sensors

Models	Connector	Options	Part Number	OEM #	Price
		Adult Box of 24	<b>S503-050</b>	570SD	<b>\$216</b>
		Pediatric Box of 24	<b>S523-050</b>	571SD	<b>\$216</b>
		Infant Box of 24	<b>S533-050</b>	572SD	<b>\$216</b>
		Neonate Box of 24	<b>S543-050</b>	573SD	<b>\$216</b>



### Criticare Adapter Cables

Models	Connector	Options	Part Number	OEM #	Price
506 Spot CSI, 507SD, 503 Spot	<p>To Monitor:</p>  <p>To Criticare Sensor:</p> 	7 Foot Adapter	<b>E708-750</b>	518DD	<b>\$60</b>
Scholar, Poet (602-3A), 1100, 581, 508, 507, 507SD, 504, 503, 501; Mindray: 500A	<p>To Monitor:</p>  <p>To Criticare Sensor:</p> 	7 Foot Adapter	<b>E708-050</b>	518LD	<b>\$60</b>

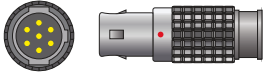
## Critikon Direct Connect Sensors

Models	Connector	Options	Part Number	OEM #	Price
Dinamap 8700, 8710, 8720 Pulse, 8721, 9710, 9700, 8280 and Oxyshuttle		Adult Clip	<b>S410-100</b>		<b>\$140</b>
		Adult Soft	<b>S410S-100</b>		<b>\$158</b>
		Pediatric Clip	<b>S110-100</b>		<b>\$140</b>
		Pediatric Soft	<b>S110S-100</b>		<b>\$158</b>
		Neonate Wrap	<b>S310-100</b>		<b>\$158</b>
		Multi-Site	<b>S810-100</b>		<b>\$158</b>

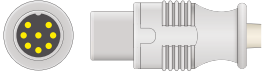
## Datascope Direct Connect Sensors

Models	Connector	Options	Part Number	OEM #	Price
Accusat, Accutorr 3 SAT, Accutorr 4 SAT, Accutorr Plus, Passport, Passport 2, Passport 2LT, Passport 5L, Passport IL, Passport EL, Passport XL, Passport XG, Datascope Multinex Plus Monitor, Datascope 3000, Passport D		Adult Clip	<b>S410-070</b>	0600-00-0026-02, 0020-00-071-01, 90651A-08	<b>\$126</b>
		Adult Soft	<b>S410S-070</b>		<b>\$126</b>
		Pediatric Clip	<b>S110-070</b>		<b>\$126</b>
		Pediatric Soft	<b>S110S-070</b>		<b>\$126</b>
		Neonate Wrap	<b>S310-070</b>		<b>\$137</b>
		Multi-Site	<b>S810-070</b>		<b>\$137</b>
		Adult Clip	<b>S410-290</b>	0600-00-0094	<b>\$116</b>
		Adult Soft	<b>S410S-290</b>		<b>\$116</b>
		Pediatric Clip	<b>S110-290</b>		<b>\$116</b>
		Pediatric Soft	<b>S110S-290</b>		<b>\$116</b>
		Neonate Wrap	<b>S310-290</b>		<b>\$126</b>
		Multi-Site	<b>S810-290</b>	0600-00-0093	<b>\$126</b>

## Datascope Short Sensors

Models	Connector	Options	Part Number	OEM #	Price
Accusat, Accutorr 3 SAT, Accutorr 4 SAT, Accutorr Plus, Passport, Passport 2, Passport 2LT, Passport IL, Passport XL and Passport XG		Adult clip	<b>S403-070</b>	0600-00-0026-01	<b>\$110</b>
		Adult soft	<b>S403S-070</b>		<b>\$110</b>
		Pediatric clip	<b>S103-070</b>		<b>\$110</b>
		Pediatric soft	<b>S103S-070</b>		<b>\$110</b>
		Neonate Wrap	<b>S303-070</b>		<b>\$118</b>
		Multi-Site	<b>S803-070</b>		<b>\$118</b>

## Datascope Disposable Sensors

Models	Connector	Options	Part Number	OEM #	Price
		Adult Box of 24	<b>S503-070</b>	0998-00-0076-05	<b>\$240</b>
		Pediatric Box of 24	<b>S523-070</b>	0998-00-0076-04	<b>\$240</b>
		Infant Box of 24	<b>S533-070</b>	0998-00-0074-03	<b>\$240</b>
		Neonate Box of 24	<b>S543-070</b>	0998-00-0074-04	<b>\$240</b>

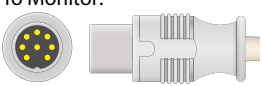
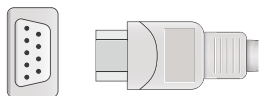

**Datascope Adapter Cables** (Also see Masimo, Mindray and Nellcor)

Models	Connector	Options	Part Number	OEM #	Price
Accusat, Accutorr 3 SAT, Accutorr 4 SAT, Accutorr Plus, Passport, Passport 2, Passport 2LT, Passport IL, Passport XL and Passport XG	<p>To Monitor:</p>  <p>To Datascope Sensor:</p> 	7 Foot Adapter	<b>E708-070</b>	0012-00-0516-01, 0012-00-0516-02	<b>\$60</b>

**Datex Ohmeda Direct Connect Sensors**

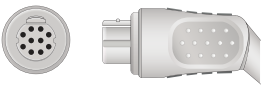
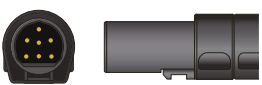
Models	Connector	Options	Part Number	OEM #	Price
Aespire, Aespire 15, AS/3, AS/3 Compact, CS/3, S/5, S/5 Compact, CH/5, CH/25, CH-RS, CG/25, Cardiacap I, Cardiacap II, Cardiacap 5, Capnomac Ultima, Light Monitor, M-Estpr, Oscar II, OSP-200, Satellite Trans, Satellite, Satellite Plus II, Trans Plus, System 5, ULTS00, OXY-E4-N, ULTSIO, ULTSVI, ULTSVO		Adult Clip	<b>S410-090</b>	OXY-F4-N, SAF-F4, TS-F4-N	<b>\$126</b>
		Adult Soft	<b>S410S-090</b>		<b>\$126</b>
		Pediatric Clip	<b>S110-090</b>		<b>\$126</b>
		Pediatric Soft	<b>S110S-090</b>		<b>\$126</b>
		Neonate Wrap	<b>S310-090</b>	OXY-W4-N	<b>\$137</b>
		Adult Ear Clip	<b>S910-090</b>	OXY-E4-N, TS-E4-N	<b>\$137</b>
		Multi-Site	<b>S810-090</b>		<b>\$137</b>
3700, 3710, 3740, 3770, 3775, 3800, 4700, 5250 RGM, OxiCap, Biox 3740, Biox 3760, Rascal II, Datex Ohmeda TuffSat 3775, 37xx Series, 3800, 3900, 3900P, 4700 and 5250 respiratory gas monitors Cardiacap/5 with N-XOSAT option, S/5, AS/3, CS/3 Modular Monitors with M-OSAT module, Modulus CD; GE 7000 Series, Corometrics 511, TRAM A.R., OXY-W4-H, TRAM Modular x00SL Series, 200SL, 400SL, 600SL, 800A, 800SL; Mennen: Horizon XL800 (Ohmeda Sp02)		Adult Clip (9 Feet)	<b>S410-020</b>	OXY-F4-H, 6051-0000-035	<b>\$126</b>
		Adult Clip (3 Feet)	<b>S403-020</b>	OXY-F1-H, 6051-6000-155, TS-F1-H	<b>\$126</b>
		Adult Soft (9 Feet)	<b>S410S-020</b>		<b>\$126</b>
		Pediatric Clip (9 Feet)	<b>S110-020</b>		<b>\$126</b>
		Pediatric Soft (9 Feet)	<b>S110S-020</b>		<b>\$126</b>
		Neonate Wrap (9 Feet)	<b>S310-020</b>	OXY-W4-H, 0380-1000-080, 0380-1000-081	<b>\$137</b>
		Adult Ear Clip (9 Feet)	<b>S910-020</b>	OXY-E4-H, 0380-1000-021, 6051-0000-188	<b>\$137</b>
		Multi-Site (9 Feet)	<b>S810-020</b>		<b>\$137</b>







**Datex Ohmeda Short Sensors**

Models	Connector	Options	Part Number	OEM #	Price
AS/3, CS/3, CH/5, CH/25, CH-RS, SAF-F, CG/25, Cardiacap I, Cardiacap II, Cardiacap 5, Capnomac Ultima, Light Monitor, M-Estpr, Oscar II, OSP-200, Satellite Trans, Satellite, Satellite Plus II, Trans Plus, System 5, ULTS00, ULTSIO, ULTSVI, ULTSVO		Adult clip	<b>S403-090</b>	OXY-F-DB, SAS-F	<b>\$110</b>
		Adult soft	<b>S403S-090</b>		<b>\$110</b>
		Pediatric clip	<b>S103-090</b>		<b>\$110</b>
		Pediatric soft	<b>S103S-090</b>		<b>\$110</b>
		Neonate Wrap	<b>S303-090</b>	OXY-W-DB, SAS-W	<b>\$118</b>
		Adult Ear Clip	<b>S903-090</b>	OXY-E-DB, SAS-E	<b>\$118</b>
		Multi-Site	<b>S803-090</b>		<b>\$118</b>

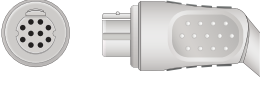
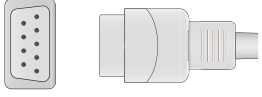
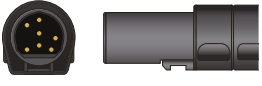

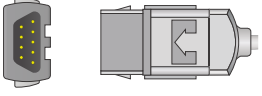

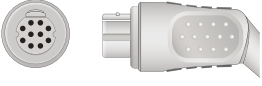





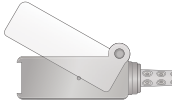

**Datex Ohmeda Disposable Sensors**

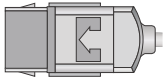
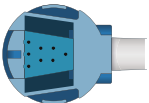
Models	Connector	Options	Part Number	OEM #	Price
		Adult Box of 24	<b>S503-090</b>	SAS-AF	<b>\$216</b>
		Pediatric Box of 24	<b>S523-090</b>	SAS-AP	<b>\$216</b>
		Infant Box of 24	<b>S533-090</b>	SAS-AP	<b>\$216</b>
		Neonate Box of 24	<b>S543-090</b>	SAS-AF	<b>\$216</b>

**Datex Ohmeda Adapter Cables**

Models	Connector	Options	Part Number	OEM #	Price
S/5, AS/3, CS/3 Modular Monitors with M-series modules, Cardiocap/5, Cardiocap S/5 Light Monitor, Capnomac Ultima, Satellite Plus II	<p>To Monitor:</p>  <p>To Datex Ohmeda DB9 Sensor:</p> 	7 Foot Adapter	<b>E708-090</b>	OXY-C3	<b>\$72</b>
	<p>To Monitor:</p>  <p>To GE TruSignal Sensor:</p> 	7 Foot Adapter	<b>E708-1120</b>	TS-H3	<b>\$96</b>
	<p>To Monitor:</p>  <p>To GE TruSignal Sensor:</p> 	7 Foot Adapter	<b>E708-1160</b>	TS-M3	<b>\$99</b>
	<p>To Monitor:</p>  <p>To GE TruSignal Sensor:</p> 	7 Foot Adapter	<b>E708-1190</b>	TS-N3	<b>\$96</b>

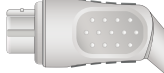
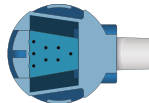
## Datex Ohmeda Adapter Cables (Continued)

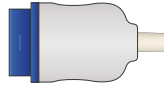
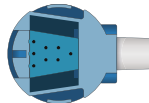
Models	Connector	Options	Part Number	OEM #	Price
	<p>To Monitor:</p>   <p>To Datex Ohmeda DB9 Sensor:</p>  	7 Foot Adapter	<b>E708-720</b>		<b>\$72</b>
Use TruSat monitors that require OxyTip+ sensors including Datex Ohmeda TruSat and Datex Ohmeda TruSat TD	<p>To Monitor:</p>   <p>To Datex Ohmeda OxyTip+ Sensor:</p> 	7 Foot Adapter	<b>E708-1600</b>	OXY-MC3	<b>\$72</b>
TuffSat, 3775, 37xx Series, 3800, 3900, 3900P, 4700 and 5250 respiratory gas monitors, Cardiocap/5 with N-XOSAT option, S/5, AS/3, CS/3 Modular Monitors with M-OSAT module	<p>To Monitor:</p>   <p>To GE TruSignal Sensor:"</p>  	7 Foot Adapter	<b>E708-1020</b>	OXY-OL3	<b>\$72</b>
Monitors that require OxyTip+ sensors including S/5, AS/3, CS/3 Modular Monitors with M-series modules, Cardiocap/5, Cardiocap S/5 Light Monitor, Capnomac Ultima, Satellite Plus II	<p>To Monitor:</p>   <p>To Datex Ohmeda OxyTip+ Sensor:</p> 	7 Foot Adapter	<b>E708-2090</b>	OXY-SL3	<b>\$72</b>
S/5, i4 Modular Monitors with E-series modules, Corometrics 259 with TruSignal technology	<p>To Monitor:</p>   <p>To Datex Ohmeda OxyTip+ Sensor:</p> 	7 Foot Adapter	<b>E708-1210</b>	OXY-ES3	<b>\$72</b>

**Datex Ohmeda Adapter Cables** (Continued)

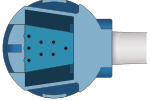

Models	Connector	Options	Part Number	OEM #	Price
Use Oxytip, Oxy-C3 connectors	<p>To Monitor:</p>  <p>To Datex Ohmeda OxyTip+ Sensor:</p> 	7 Foot Adapter	<b>E708-810</b>	OXY-SLA, OXY-SLC	<b>\$72</b>

**Dinamap** (See Nellcor and Marquette)

**Dolphin Short Sensors**

Models	Connector	Options	Part Number	OEM #	Price
Dolphin ONE Oximeters 210, 2150, 2100, 2G00751		Adult clip	<b>S403-50D0</b>	201, 360, 360	<b>\$129</b>
		Adult soft	<b>S403S-50D0</b>		<b>\$202</b>

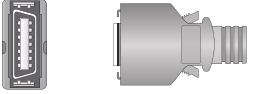
**Dolphin Adapter Cables**

Models	Connector	Options	Part Number	OEM #	Price
	<p>To Monitor:</p>  <p>To Dolphin Sensor:</p> 	7 Foot Adapter	<b>E708-500</b>		<b>\$96</b>



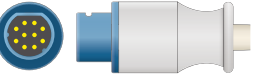

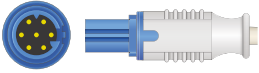

**Drager Direct Connect Sensors**

Models	Connector	Options	Part Number	OEM #	Price
Siemens, Sirecust 700, Sirecust 630, Sirem SpO2 Module		Adult Clip	<b>S410-330</b>		<b>\$126</b>
		Adult Soft	<b>S410S-330</b>		<b>\$126</b>
		Pediatric Clip	<b>S110-330</b>		<b>\$126</b>
		Pediatric Soft	<b>S110S-330</b>		<b>\$126</b>
		Neonate Wrap	<b>S310-330</b>		<b>\$137</b>
		Multi-Site	<b>S810-330</b>		<b>\$137</b>

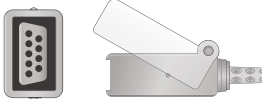
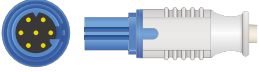
**Dräger Direct Connect Sensors (Continued)**

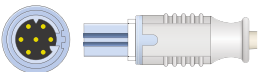
Models	Connector	Options	Part Number	OEM #	Price
SC6002XL, 7000, SC8000, SC9000X, Infinity Vista and Infinity Delta		Adult Clip	<b>S410-230</b>		<b>\$126</b>
		Adult Soft	<b>S410S-230</b>		<b>\$126</b>
		Pediatric Clip	<b>S110-230</b>		<b>\$126</b>
		Pediatric Soft	<b>S110S-230</b>		<b>\$126</b>
		Neonate Wrap	<b>S310-230</b>		<b>\$137</b>
		Multi-Site	<b>S810-230</b>		<b>\$137</b>

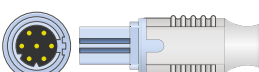

**Dräger Adapter Cables**

Models	Connector	Options	Part Number	OEM #	Price
Sirecust 700, Sirecust 630, Sirem SpO2 Module	<p>To Monitor:</p>  <p>To Nellcor non-Oximax Sensor:</p> 	7 Foot Adapter	<b>E708-330</b>		<b>\$72</b>
Infinity Vista, Delta, Gamma, Kappa MultiMed Pod; Siemens SC 6002XL, SC7000, SC8000, SC9000XL	<p>To Monitor:</p>  <p>To Nellcor non-Oximax Sensor:</p> 	7 Foot Adapter	<b>E708-230</b>	3368433, 3375834	<b>\$60</b>
Infinity Vista, Delta, Gamma and Kappa MultiMed Pod for Nellcor Oximax sensor	<p>To Monitor:</p>  <p>To Nellcor Oximax Sensor:</p> 	10 Foot Adapter	<b>E710P-230</b>	MS17330	<b>\$99</b>
Draeger monitors with Masimo SpO2 technology	<p>To Monitor:</p>  <p>To Masimo LNCS Sensor</p> 	7 Foot Adapter	<b>E708M-230</b>	MS17522	<b>\$72</b>

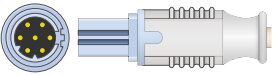
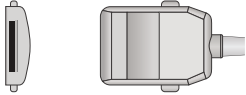
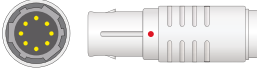
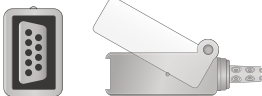

**Drager Adapter Cables (Continued)**

Models	Connector	Options	Part Number	OEM #	Price
Infinity Vista, Delta, Gamma and Kappa MultiMed Pod	<p>To Monitor:</p>  <p>To Masimo LNOP Sensor:</p> 	7 Foot Adapter	<b>E708M-23P0</b>	MS17041	<b>\$72</b>
Vitalert 1000, Cicero, Julian	<p>To Monitor:</p>  <p>To Nellcor non-Oximax Sensor:</p> 	7 Foot Adapter	<b>E708-280</b>	M35371, M35370, 5720084	<b>\$72</b>

**Edan Direct Connect Sensors (Also see Mindray)**







Models	Connector	Options	Part Number	OEM #	Price
M3, M3B, M8, M8A, M8B, M9, M9A, M50, M80, iM9, iM9A, iM50, iM80 with Oximax technology		Adult Clip	<b>S410-191P0</b>		<b>\$126</b>
		Adult Soft	<b>S410S-191P0</b>		<b>\$126</b>
		Pediatric Clip	<b>S110-191P0</b>		<b>\$126</b>
		Pediatric Soft	<b>S110S-191P0</b>		<b>\$126</b>
		Neonate Wrap	<b>S310-191P0</b>		<b>\$137</b>
		Multi-Site	<b>S810-191P0</b>		<b>\$137</b>
Digital Tech Sensors; Contec; Promed PM7000; Sinohero S80; Risingmed RPM9000C		Adult Clip	<b>S410-46D0</b>		<b>\$126</b>
		Adult Soft	<b>S410S-46D0</b>		<b>\$126</b>
		Pediatric Clip	<b>S110-46D0</b>		<b>\$126</b>
		Pediatric Soft	<b>S110S-46D0</b>		<b>\$126</b>
		Neonate Wrap	<b>S310-46D0</b>		<b>\$137</b>
		Multi-Site	<b>S810-46D0</b>		<b>\$137</b>

**Edan Adapter Cables**







Models	Connector	Options	Part Number	OEM #	Price
M3, M3B, M8, M8A, M8B, M9, M9A, M50, M80, iM9, iM9A, iM50, iM80 with Oximax technology	<p>To Monitor:</p>  <p>To Nellcor Oximax Sensor:</p> 	7 Foot Adapter	<b>E708P-1910</b>		<b>\$84</b>

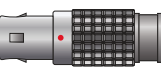

Goldway Direct Connect Sensors

Models	Connector	Options	Part Number	OEM #	Price
UT4000A, UT4000F, UT4000; Choice Electronics MMED6000DP	 	Adult Clip	<b>S410-370</b>		<b>\$126</b>
		Adult Soft	<b>S410S-370</b>		<b>\$126</b>
		Pediatric Clip	<b>S110-370</b>		<b>\$126</b>
		Pediatric Soft	<b>S110S-370</b>		<b>\$126</b>
		Neonate Wrap	<b>S310-370</b>		<b>\$137</b>
		Multi-Site	<b>S810-370</b>		<b>\$137</b>
Goldway monitors and DRE Spectra AG5	 	Adult Clip	<b>S410-380</b>		<b>\$116</b>
		Adult Soft	<b>S410S-380</b>		<b>\$123</b>
4000B	 	Adult Clip	<b>S410-110</b>		<b>\$112</b>
		Adult Soft	<b>S410S-110</b>		<b>\$112</b>
		Pediatric Clip	<b>S110-110</b>		<b>\$112</b>
		Pediatric Soft	<b>S110S-110</b>		<b>\$112</b>
		Neonate Wrap	<b>S310-110</b>		<b>\$126</b>
		Multi-Site	<b>S810-110</b>		<b>\$126</b>

Goldway Adapter Cables

Models	Connector	Options	Part Number	OEM #	Price
UT4000C, UT4000E, UT4000Apro, UT4000Fpro, UT6000A	<p>To Monitor:</p>   <p>To Nellcor non-Oximax Sensor:</p>  	7 Foot Adapter	<b>E708-110</b>		<b>\$72</b>
UT4000F, Pace Tech	<p>To Monitor:</p>   <p>To Nellcor non-Oximax Sensor:</p>  	7 Foot Adapter	<b>E708-370</b>		<b>\$72</b>

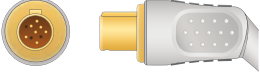

## Hellige Direct Connect Sensors

Models	Connector	Options	Part Number	OEM #	Price
Servomed 4 Generation SCP 844, 851, 852 SCS 804, SMK 151, 153, 154, 155-1, 156, 157, SMK181, 182, SMV 104T, 107, 111, 168, SMS316, SMC108, SMV104, Servomed N4, Servocard, Cardioserv Series, Vicom SM, SMU 511, 611, 612, 630, SMK-200, SMK210, 211, 230, 231, 240, 250, SMP 300, 310, Pepita 201, 202, 202 R, 203, Pepita 203, R204, 204R, 205, Pepita 205R		Adult Clip	<b>S410-550</b>		<b>\$112</b>
		Adult Soft	<b>S410S-550</b>		<b>\$112</b>
		Pediatric Clip	<b>S110-550</b>		<b>\$112</b>
		Pediatric Soft	<b>S110S-550</b>		<b>\$112</b>
		Neonate Wrap	<b>S310-550</b>		<b>\$126</b>
		Multi-Site	<b>S810-550</b>		<b>\$126</b>

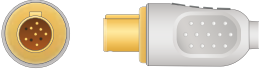
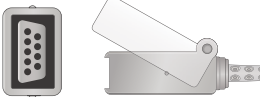

## Hellige Adapter Cables

Models	Connector	Options	Part Number	OEM #	Price
Cardioserv, Eagle 1000, Eagle 4000	<p>To Monitor:</p>  <p>To Nellcor non-Oximax Sensor:</p> 	7 Foot Adapter	<b>E708-550</b>	30344358	<b>\$72</b>

## Infinium Direct Connect Sensors

Models	Connector	Options	Part Number	OEM #	Price
OmniOne, Infinium Omni II, Infinium Infitron		Adult Clip	<b>S410-97D0</b>		<b>\$126</b>
		Adult Soft	<b>S410S-97D0</b>		<b>\$126</b>
		Pediatric Clip	<b>S110-97D0</b>		<b>\$126</b>
		Pediatric Soft	<b>S110S-97D0</b>		<b>\$126</b>
		Neonate Wrap	<b>S310-97D0</b>		<b>\$137</b>
		Multi-Site	<b>S810-97D0</b>		<b>\$137</b>
		Adult Clip	<b>S410-137D0</b>		<b>\$126</b>
		Adult Soft	<b>S410S-137D0</b>		<b>\$126</b>
		Pediatric Clip	<b>S110-137D0</b>		<b>\$126</b>
		Pediatric Soft	<b>S110S-137D0</b>		<b>\$126</b>
		Neonate Wrap	<b>S310-137D0</b>		<b>\$137</b>
		Multi-Site	<b>S810-137D0</b>		<b>\$137</b>
		Adult Clip	<b>S410-1470</b>		<b>\$112</b>
		Adult Soft	<b>S410S-1470</b>		<b>\$112</b>
		Pediatric Clip	<b>S110-1470</b>		<b>\$112</b>
		Pediatric Soft	<b>S110S-1470</b>		<b>\$112</b>
		Neonate Wrap	<b>S310-1470</b>		<b>\$126</b>
		Multi-Site	<b>S810-1470</b>		<b>\$126</b>

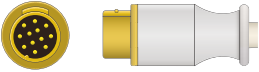

**Infinium Adapter Cables**

Models	Connector	Options	Part Number	OEM #	Price
Mira, Vega; Larsen & Toubro (L&T): Planet 50	<p>To Monitor:</p>  <p>To Nellcor Oximax Sensor:</p> 	10 Foot Adapter	<b>E710P-830</b>		<b>\$84</b>

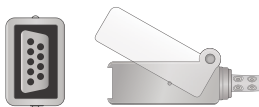

**Invivo Direct Connect Sensors**

Models	Connector	Options	Part Number	OEM #	Price
4500, 4500 Plus, Millennia, Omega 1445, Omni-Trak TVS, Sat Scout		Adult Clip	<b>S410-140</b>	9383	<b>\$126</b>
		Adult Soft	<b>S410S-140</b>		<b>\$126</b>
		Pediatric Clip	<b>S110-140</b>		<b>\$126</b>
		Pediatric Soft	<b>S110S-140</b>		<b>\$126</b>
		Neonate Wrap	<b>S310-140</b>		<b>\$137</b>
		Multi-Site	<b>S810-140</b>		<b>\$137</b>

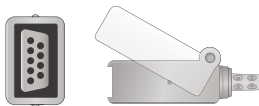
**Invivo Adapter Cables**

Models	Connector	Options	Part Number	OEM #	Price
4500 Plus, 4500 Plus 3, Millennia, Omega 14 45, Omni-TrakTVS, Sat Scout	<p>To Monitor:</p>  <p>To Nellcor non-Oximax Sensor:</p> 	7 Foot Adapter	<b>E708-140</b>	9383	<b>\$72</b>
M8, M12	<p>To Monitor:</p>  <p>To Nellcor non-Oximax Sensor:</p> 	7 Foot Adapter	<b>E708-14M0</b>		<b>\$72</b>

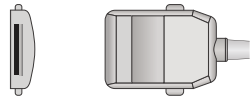
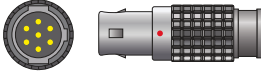
**Invivo Adapter Cables** (Continued)

Models	Connector	Options	Part Number	OEM #	Price
M8, M12, Escort M with Masimo technology	To Monitor:   To Masimo LNOP Sensor: 	7 Foot Adapter	<b>E708M-14P0</b>	9217A, 9289A, 9289B, 9217B	<b>\$72</b>
M8, M12 with Masimo technology	To Monitor:   To Masimo LNCS Sensor: 	7 Foot Adapter	<b>E708M-140</b>		<b>\$72</b>



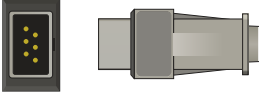

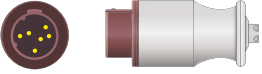

**Konica Minolta Short Sensors**

Models	Connector	Options	Part Number	OEM #	Price
Pulsox-300, Pulsox-300i and Check Probe SP5C		Adult Clip	<b>S401-1050</b>	R124P50	<b>\$165</b>
		Adult Soft	<b>S401S-1050</b>		<b>\$165</b>
		Pediatric Clip	<b>S101-1050</b>		<b>\$165</b>
		Pediatric Soft	<b>S101S-1050</b>		<b>\$165</b>
		Neonate Wrap	<b>S301-1050</b>		<b>\$195</b>
		Multi-Site	<b>S801-1050</b>		<b>\$195</b>

**Kontron Direct Connect Sensors**

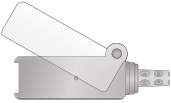
Models	Connector	Options	Part Number	OEM #	Price
7138, 7840, 7845, Minimon 7137 and 7337, Micromon, Supermon, Kolormon, Trakmon		Adult Clip	<b>S410-130</b>	608010	<b>\$126</b>
		Adult Soft	<b>S410S-130</b>		<b>\$126</b>
		Pediatric Clip	<b>S110-130</b>		<b>\$126</b>
		Pediatric Soft	<b>S110S-130</b>		<b>\$126</b>
		Neonate Wrap	<b>S310-130</b>		<b>\$137</b>
		Multi-Site	<b>S810-130</b>		<b>\$137</b>

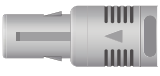

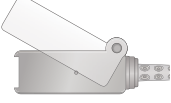
### Kontron Adapter Cables

Models	Connector	Options	Part Number	OEM #	Price
	<p>To Monitor:</p>   <p>To Nellcor non-Oximax Sensor:</p>  	7 Foot Adapter	<b>E708-130</b>		<b>\$72</b>
	<p>To Monitor:</p>   <p>To Nellcor non-Oximax Sensor:</p>  	7 Foot Adapter	<b>E708-530</b>		<b>\$72</b>

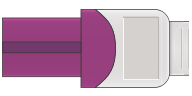
### Lohmeier Direct Connect Sensors

Models	Connector	Options	Part Number	OEM #	Price
M010	 	Adult Clip	<b>S410-640</b>	6051-0000-035	<b>\$126</b>
		Adult Soft	<b>S410S-640</b>		<b>\$126</b>
		Pediatric Clip	<b>S110-640</b>		<b>\$126</b>
		Pediatric Soft	<b>S110S-640</b>		<b>\$126</b>
		Neonate Wrap	<b>S310-640</b>		<b>\$137</b>
		Multi-Site	<b>S810-640</b>		<b>\$137</b>

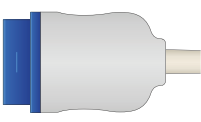

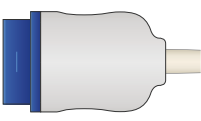

### Marquette (GE) Direct Connect Sensors

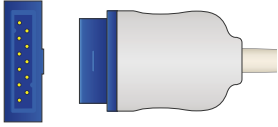
Models	Connector	Options	Part Number	OEM #	Price
Eagle, Dash, Solar Series, GE Responder 2000, Responder 3000 and Series Tram Modular x50SL with Nellcor technology	 	Adult Clip	<b>S410-210</b>	407705-006	<b>\$126</b>
		Adult Soft	<b>S410S-210</b>		<b>\$126</b>
		Pediatric Clip	<b>S110-210</b>		<b>\$126</b>
		Pediatric Soft	<b>S110S-210</b>		<b>\$126</b>
		Neonate Wrap	<b>S310-210</b>		<b>\$137</b>
		Multi-Site	<b>S810-210</b>		<b>\$137</b>
Corometrics 250cx and Marquette monitors with Oximax technology	 	Adult Clip	<b>S410-21P0</b>	2025350-001, 2021406-001	<b>\$126</b>
		Adult Soft	<b>S410S-21P0</b>		<b>\$126</b>
		Pediatric Clip	<b>S110-21P0</b>		<b>\$126</b>
		Pediatric Soft	<b>S110S-21P0</b>		<b>\$126</b>
		Neonate Wrap	<b>S310-21P0</b>		<b>\$137</b>
		Multi-Site	<b>S810-21P0</b>		<b>\$137</b>

## Marquette (GE) Direct Connect Sensors (Continued)

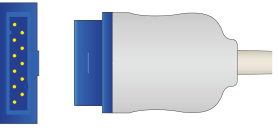
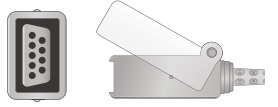
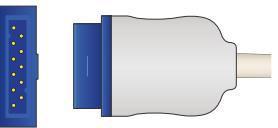
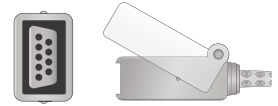
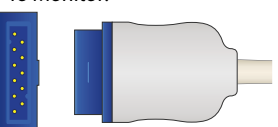

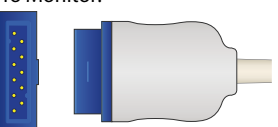
Models	Connector	Options	Part Number	OEM #	Price
Dash 2000, 3000, 4000, 5000, i/9500 (Tram 451N5/851N5). Solar 7000, 8000 e Eagle 1000, 3000, Smk SMV, Corometrics 250 with Masimo technology		Adult Clip	<b>S410-21M0</b>	TS-F2-GE, TS-F4-GE	<b>\$126</b>
		Adult Soft	<b>S410S-21M0</b>	TS-SA4-GE	<b>\$126</b>
		Pediatric Clip	<b>S110-21M0</b>		<b>\$126</b>
		Pediatric Soft	<b>S110S-21M0</b>		<b>\$126</b>
		Neonate Wrap	<b>S310-21M0</b>		<b>\$137</b>
		Multi-Site	<b>S810-21M0</b>		<b>\$137</b>

## Marquette (GE) Adapter Cables

Models	Connector	Options	Part Number	OEM #	Price
Eagle, Dash, SOLAR, TRAM Modular and x50SL Series, GE Carescape Dinamap V100 with Nellcor technology, Corometrics TRAM 450SL, Corometrics 0128 without Oximax technology	To Monitor:  To Nellcor non-Oximax Sensor: 	7 Foot Adapter	<b>E708-210</b>	2006644-001, 407252-002, E9004DE, TE2423, CB-A400-1102A	<b>\$72</b>
For use on monitors with the Oximax SpO2 module for use with non-Oximax sensors	To Monitor:  To Nellcor non-Oximax Sensor: 	7 Foot Adapter	<b>E708-21P0</b>		<b>\$72</b>
GE Carescape Dinamap V100, Dash 3000, Dash 4000, Dash 5000, Solar 8000, Solar 8000M, i9500 with Tram module 451N5/851N5, GE 250CX, Corometrics 250, GE Corometrics 259 Fetal Monitor with Oximax technology	To Monitor:  To Nellcor Oximax Sensor: 	7 Foot Adapter	<b>E710P-210</b>	2021406-001, 2025350-001, 20221406-001	<b>\$72</b>
Dash, Solar, Carescape Dinamap V100 with Masimo technology	To Monitor:  To Nellcor non-Oximax Sensor: 	7 Foot Adapter	<b>E708-21M0</b>		<b>\$ 72</b>

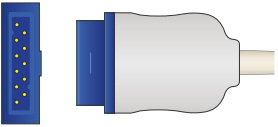
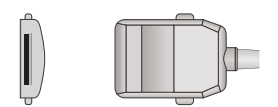
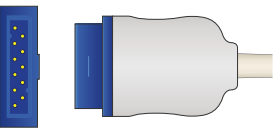

**Marquette (GE) Adapter Cables (Continued)**

Models	Connector	Options	Part Number	OEM #	Price
Corometrics 250, Corometrics 259, Dash 3000, Dash, 4000, Dash 5000 with Masimo option, Solar 8000/8000M, i/9500 with Tram Module 451M/851M, CardioLab/Mac-Lab with Tram Module 451M, Datex Ohmeda Giraffe Infant Warmer	<p>To Monitor:</p>  <p>To Masimo LNOP Sensor:</p> 	7 Foot Adapter	<b>E708M-21P0</b>	2017002-00, 2017002-001, 2017002-003, 2016041-00, 2016041-01, 2016041-02, PC-12-GE 1890	<b>\$72</b>
Dash, Solar, Careescape Dinamap V100 with Masimo technology	<p>To Monitor:</p>  <p>To Masimo LNCS Sensor:</p> 	7 Foot Adapter	<b>E708M-210</b>	LCN-10-GE 2016, 2027263-002, PS-10153D	<b>\$72</b>

**Masimo Direct Connect Sensors**

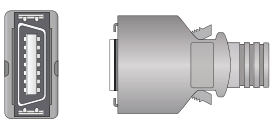
Models	Connector	Options	Part Number	OEM #	Price
		Adult Clip	<b>S410-150</b>	DC-8 2387, 2027277-001, 01-02-0730, 01-02-0712, 0600-00-0120	<b>\$126</b>
		Adult Soft	<b>S410S-150</b>	DBI-DC8 2653	<b>\$126</b>
		Pediatric Clip	<b>S110-150</b>		<b>\$126</b>
		Pediatric Soft	<b>S110S-150</b>		<b>\$126</b>
		Neonate Wrap	<b>S310-150</b>		<b>\$137</b>
		Multi-Site	<b>S810-150</b>		<b>\$137</b>

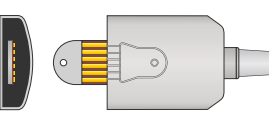

**Masimo Short Sensors**

Models	Connector	Options	Part Number	OEM #	Price
Masimo LNOP Sensor		Adult Clip	<b>S403-1250</b>	1269 LNOP DCI, 0600-00-0047, 7270312, 2002800-001, 9898031 40321, 690-0230-00	<b>\$110</b>
		Adult Soft	<b>S403S-1250</b>		<b>\$110</b>
		Pediatric Clip	<b>S103-1250</b>	1276 LNOP DCIP, 0600-00-0063, 7270304, 2002799-001, 9898031 40331, 690-0231-00	<b>\$110</b>
		Pediatric Soft	<b>S103S-1250</b>		<b>\$110</b>
		Neonate Wrap	<b>S303-1250</b>		<b>\$118</b>
		Adult Ear Clip	<b>S903-1250</b>	2027274-001, 9898031 40341	<b>\$118</b>
		Multi-Site	<b>S803-1250</b>	1544 LNOP YI, 0600-00-0078, 7497014, 2010463-001, 690-0232-00	<b>\$118</b>

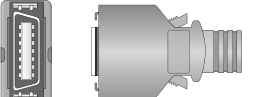

## Masimo Short Sensors (Continued)

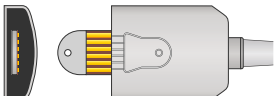
Models	Connector	Options	Part Number	OEM #	Price
Masimo LNCS Sensor		Adult Clip	<b>S403-490</b>	1863 LNCS DCI, 0010-10-42600, 0600-00-0126, MP00796, 9898031 48281, 01-02-0905, 2.100309, 2027258-001, 8000-0294	<b>\$110</b>
		Adult Soft	<b>S403S-490</b>	2653 LNCS DBI	<b>\$110</b>
		Pediatric Clip	<b>S103-490</b>	1864 LNCS DCIP, 01-02-0906, 0010-10-42634, 0600-00-0127, MP00795, 9898031 48291, 2027259-001	<b>\$110</b>
		Pediatric Soft	<b>S103S-490</b>		<b>\$110</b>
		Neonate Wrap	<b>S303-490</b>		<b>\$118</b>
		Adult Ear Clip	<b>S903-490</b>	1895 LNCS TC-I, 2027261-001, 9898031 48301	<b>\$118</b>
		Multi-Site	<b>S803-490</b>	2258 LNCS YI, MP00789	<b>\$118</b>
		Adult Clip	<b>S402-150</b>	LNOP DCSC 1396, 01-02-0700	<b>\$112</b>





## Masimo Disposable Sensors

Models	Connector	Options	Part Number	OEM #	Price
LNOP disposable sensor		Adult Box of 24	<b>S503-1250</b>	LNOP Amtx	<b>\$240</b>
		Pediatric Box of 24	<b>S523-1250</b>	LNOP Pmtx	<b>\$240</b>
		Infant Box of 24	<b>S533-1250</b>	LNOP INF	<b>\$240</b>
		Neonate Box of 24	<b>S543-1250</b>	LNOP Neo	<b>\$240</b>
		Adult Box of 24	<b>S503-490</b>	1859 LNCS Amtx, 2027253-001	<b>\$216</b>
		Pediatric Box of 24	<b>S523-490</b>	1860 LNCS Pmtx, 2027254-001	<b>\$216</b>
		Infant Box of 24	<b>S533-490</b>	2328 LNCS INF, 2027255-001, 1777, 2319	<b>\$216</b>
		Neonate Box of 24	<b>S543-490</b>	2329 LNCS Neo, 2027256-001, 2320	<b>\$216</b>

## Masimo Adapter Cables

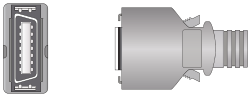
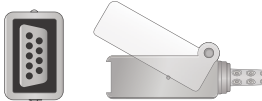
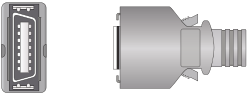
Models	Connector	Options	Part Number	OEM #	Price
All Masimo; MDE: Escort II OPT30; Prism; GE Marquette: Pro1000, V300; Invivo: T8; Schiller; Zoll; Datascope: Trio, Passport 2, Spectrum	To Monitor: 	4 Foot Adapter	<b>E704M-490</b>	LNC-4-Ext, 2021, 01-02-0715	<b>\$72</b>
		7 Foot Adapter	<b>E708M-490</b>	LNC MAC-180, 2268, 8000-0325	<b>\$72</b>
	To Masimo LNCS Sensor: 				

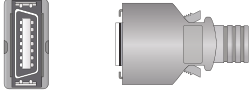
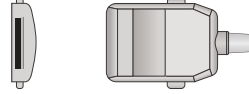

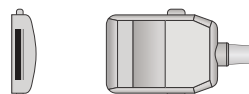
**Masimo Adapter Cables (Continued)**

Models	Connector	Options	Part Number	OEM #	Price
Masimo adapter cable for use with Nellcor non-Oximax sensors	<p>To Monitor:</p>  <p>To Nellcor non-Oximax Sensor:</p> 	7 Foot Adapter	<b>E708-150</b>		<b>\$72</b>
Datascope Accutorr V, Duo, Passport 2, Passport 2LT, Passport V, Spectrum, Spectrum OR, Trio, V12, V21; Medtronic Physio Control: Lifepak 11, Lifepak 12, Lifepak 15, Lifepak 20; Welch Allyn: Spot Vital Signs 42MTB-E1, 45NE0-E1 LX; Zoll: E Series, M Series, R Series	<p>To Monitor:</p>  <p>To Masimo LNCS Sensor:</p> 	1 Foot Adapter	<b>E701M-150</b>	LNC-1 2364	<b>\$72</b>
		4 Foot Adapter	<b>E704M-150</b>	LNC-4 2017, 01-02-0903	<b>\$72</b>
		7 Foot Adapter	<b>E708M-150</b>	0012-00-1652, 0012-00-1653, 0012-00-1599, 2027263-001	<b>\$72</b>
		10 Foot Adapter	<b>E710M-150</b>	LNC-10 1814, 01-02-0904	<b>\$72</b>
Equipment that require LNOP-type sensors including the Atom V-2100G incubator	<p>To Monitor:</p>  <p>To Masimo LNOP Sensor:</p> 	4 Foot Adapter	<b>E704M-15P0</b>	PC04 1173	<b>\$72</b>
		8 Foot Adapter	<b>E708M-15P0</b>	PC08 1005, 0012-00-1099-01, 0012-00-1099-02, 2009743-001, 2027278-001, 01-02-0182, 01-02-0192, 01-02-0445	<b>\$72</b>
		12 Foot Adapter	<b>E711M-15P0</b>	PC12 1006	<b>\$72</b>
Datascope: Accutorr V, Duo, Passport 2, Passport V, Spectrum, Spectrum OR, Trio, V12, V21	<p>To Monitor:</p>  <p>To Masimo LNOP Sensor:</p> 	4 Foot Adapter	<b>E704M-49P0</b>	MAC-1 1927, 0012-00-1656	<b>\$72</b>

**Meditech Direct Connect Sensors**

Models	Connector	Options	Part Number	OEM #	Price
D3D, G3C, G3F, G3H, G3L		Adult Clip	<b>S410-65D0</b>		<b>\$112</b>
		Adult Soft	<b>S410S-65D0</b>		<b>\$112</b>
		Pediatric Clip	<b>S110-65D0</b>		<b>\$112</b>
		Pediatric Soft	<b>S110S-65D0</b>		<b>\$112</b>
		Neonate Wrap	<b>S310-65D0</b>		<b>\$126</b>
		Multi-Site	<b>S810-65D0</b>		<b>\$126</b>

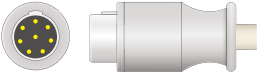
**Medtronic** (See Masimo and Nellcor Adapter Cables)**MEK Direct Connect Sensors**

Models	Connector	Options	Part Number	OEM #	Price
New MEK monitors		Adult Clip	<b>S410-560</b>		<b>\$140</b>
		Adult Soft	<b>S410S-560</b>		<b>\$158</b>
		Neonate Wrap	<b>S310-560</b>		<b>\$158</b>
MP 100, MP 110, MP 400, MP 500, MP 600, MP 1000; Votem VP-700, VP-1000, VP-1200		Adult Clip	<b>S410-260</b>		<b>\$126</b>
		Adult Soft	<b>S410S-260</b>		<b>\$126</b>
		Pediatric Clip	<b>S110-260</b>		<b>\$126</b>
		Pediatric Soft	<b>S110S-260</b>		<b>\$126</b>
		Neonate Wrap	<b>S310-260</b>		<b>\$137</b>
		Multi-Site	<b>S810-260</b>		<b>\$137</b>
MP 7000		Adult Clip	<b>S410-270</b>		<b>\$126</b>
		Adult Soft	<b>S410S-270</b>		<b>\$126</b>
		Pediatric Clip	<b>S110-270</b>		<b>\$126</b>
		Pediatric Soft	<b>S110S-270</b>		<b>\$126</b>
		Neonate Wrap	<b>S310-270</b>		<b>\$137</b>
		Multi-Site	<b>S810-270</b>		<b>\$137</b>

**MEK Short Sensors**

Models	Connector	Options	Part Number	OEM #	Price
MP100, MP110, MP400, MP500, MP600, and MP1000		Adult clip	<b>S403-260</b>		<b>\$110</b>
		Adult soft	<b>S403S-260</b>		<b>\$110</b>
		Pediatric clip	<b>S103-260</b>		<b>\$110</b>
		Pediatric soft	<b>S103S-260</b>		<b>\$110</b>
		Neonate Wrap	<b>S303-260</b>		<b>\$118</b>
		Multi-Site	<b>S803-260</b>		<b>\$118</b>

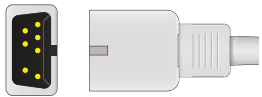

**MEK Disposable Sensors**

Models	Connector	Options	Part Number	OEM #	Price
		Adult Box of 24	<b>S503-260</b>		<b>\$216</b>
		Pediatric Box of 24	<b>S523-260</b>		<b>\$216</b>
		Infant Box of 24	<b>S533-260</b>		<b>\$216</b>
		Neonate Box of 24	<b>S543-260</b>		<b>\$216</b>

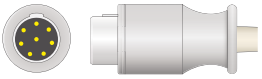
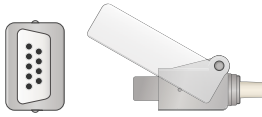

**MEK Adapter Cables**

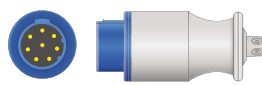
Models	Connector	Options	Part Number	OEM #	Price
	<p>To Monitor:</p>  <p>To Nellcor non-Oximax Sensor</p> 	7 Foot Adapter	<b>E708-560</b>		<b>\$72</b>

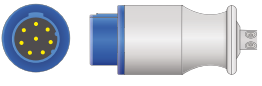
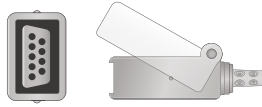

**Mennen Direct Connect Sensors**

Models	Connector	Options	Part Number	OEM #	Price
		Adult Clip	<b>S410-540</b>		<b>\$126</b>
		Adult Soft	<b>S410S-540</b>		<b>\$126</b>
		Pediatric Clip	<b>S110-540</b>		<b>\$126</b>
		Pediatric Soft	<b>S110S-540</b>		<b>\$126</b>
		Neonate Wrap	<b>S310-540</b>		<b>\$137</b>
		Multi-Site	<b>S810-540</b>		<b>\$137</b>
Horizon 2000		Adult Clip	<b>S410-240</b>		<b>\$126</b>
		Adult Soft	<b>S410S-240</b>		<b>\$126</b>
		Pediatric Clip	<b>S110-240</b>		<b>\$126</b>
		Pediatric Soft	<b>S110S-240</b>		<b>\$126</b>
		Neonate Wrap	<b>S310-240</b>		<b>\$137</b>
		Multi-Site	<b>S810-240</b>		<b>\$165</b>

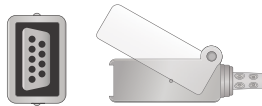

**Mennen Adapter Cables**

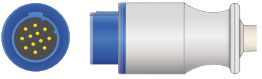
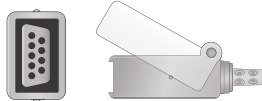
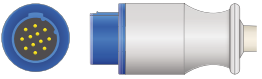
Models	Connector	Options	Part Number	OEM #	Price
	<p>To Monitor:</p>  <p>To Nellcor non-Oximax Sensor:</p> 	7 Foot Adapter	<b>E708-540</b>		<b>\$72</b>
	<p>To Monitor:</p>  <p>To Nellcor non-Oximax Sensor:</p> 	7 Foot Adapter	<b>E708-240</b>	261-877-070	<b>\$72</b>

**Mennen Adapter Cables (Continued)**



Models	Connector	Options	Part Number	OEM #	Price
	To Monitor:  To Nellcor non-Oximax Sensor: 	7 Foot Adapter	<b>E708-59M0</b>	551-306-321	<b>\$72</b>
	To Monitor:  To Nellcor non-Oximax Sensor: 	7 Foot Adapter	<b>E708M-590</b>		<b>\$72</b>

**Mindray Direct Connect Sensors**

Models	Connector	Options	Part Number	OEM #	Price
PM 600, PM 6000 (New), PM 7000, 6201, PM 8000, PM 9000, PM 9000 Express, MEC 100, MEC 200, MEC 1000, MEC 1200, 809B, VS 800; Mennen Enmove 1000, Mercury; Kontron: 7138, 7840, 7845; Medec: MEDEC-1000, M-1000, M-1100; Creative: PC9000, UP6000; Edan: M3, M3A, M3B, M8, M8A, M8B, M9, M9A, M50, M80, iM8, iM8A, iM8B, iM9, iM9A, iM50, iM80; Goldway, Contec and Danatech, Penlon Intermed PM 8000		Adult Clip	<b>S410-290</b>		<b>\$116</b>
		Adult Soft	<b>S410S-290</b>		<b>\$116</b>
		Pediatric Clip	<b>S110-290</b>		<b>\$116</b>
		Pediatric Soft	<b>S110S-290</b>		<b>\$116</b>
		Neonate Wrap	<b>S310-290</b>		<b>\$126</b>
		Multi-Site	<b>S810-290</b>		<b>\$126</b>
PM 6000, PM 6201, PM 7000, PM 8000, PM 9000 Express, PM 9000, PM 9100, PM 9200P, M1K0, M2K0 (before January 2006) with Masimo technology		Adult Clip	<b>S410-30M0</b>		<b>\$126</b>
		Adult Soft	<b>S410S-30M0</b>		<b>\$126</b>
		Pediatric Clip	<b>S110-30M0</b>		<b>\$126</b>
		Pediatric Soft	<b>S110S-30M0</b>		<b>\$126</b>
		Neonate Wrap	<b>S310-30M0</b>		<b>\$137</b>
Multi-Site	<b>S810-30M0</b>		<b>\$137</b>		
PM 6000 and PM 8000 with Masimo technology		Adult Clip	<b>S410-29M0</b>		<b>\$126</b>
		Adult Soft	<b>S410S-29M0</b>		<b>\$126</b>
		Pediatric Clip	<b>S110-29M0</b>		<b>\$126</b>
		Pediatric Soft	<b>S110S-29M0</b>		<b>\$126</b>
		Neonate Wrap	<b>S310-29M0</b>		<b>\$137</b>
Multi-Site	<b>S810-29M0</b>		<b>\$137</b>		

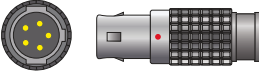
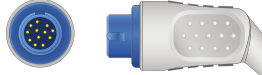

**Mindray Direct Connect Sensors (Continued)**

Models	Connector	Options	Part Number	OEM #	Price
503, 507, 508, 509, Mindray PM 9000 with Criticare technology		Adult Clip	<b>S410-310</b>		<b>\$126</b>
		Adult Soft	<b>S410S-310</b>		<b>\$126</b>
		Pediatric Clip	<b>S110-310</b>		<b>\$126</b>
		Pediatric Soft	<b>S110S-310</b>		<b>\$126</b>
		Neonate Wrap	<b>S310-310</b>		<b>\$137</b>
		Multi-Site	<b>S810-310</b>		<b>\$137</b>
PM 5000, PM 6000, PM 8000		Adult Clip	<b>S410-220</b>		<b>\$126</b>
		Adult Soft	<b>S410S-220</b>		<b>\$126</b>
		Pediatric Clip	<b>S110-220</b>		<b>\$126</b>
		Pediatric Soft	<b>S110S-220</b>		<b>\$126</b>
		Neonate Wrap	<b>S310-220</b>		<b>\$137</b>
Multi-Site	<b>S810-220</b>		<b>\$137</b>		
PM 6000 with Masimo technology		Adult Clip	<b>S410-22M0</b>		<b>\$126</b>
		Adult Soft	<b>S410S-22M0</b>		<b>\$126</b>
		Pediatric Clip	<b>S110-22M0</b>		<b>\$126</b>
		Pediatric Soft	<b>S110S-22M0</b>		<b>\$126</b>
		Neonate Wrap	<b>S310-22M0</b>		<b>\$137</b>
Multi-Site	<b>S810-22M0</b>		<b>\$137</b>		
BeneView T5, T8 and iPM-8900		Adult Clip	<b>S410-480</b>		<b>\$126</b>
		Adult Soft	<b>S410S-480</b>		<b>\$126</b>
		Pediatric Clip	<b>S110-480</b>		<b>\$126</b>
		Pediatric Soft	<b>S110S-480</b>		<b>\$126</b>
		Neonate Wrap	<b>S310-480</b>		<b>\$137</b>
Multi-Site	<b>S810-480</b>		<b>\$137</b>		

**Mindray Adapter Cables**

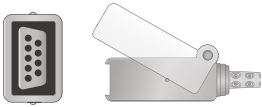
Models	Connector	Options	Part Number	OEM #	Price
MEC 100, MEC 200, PM 7000, 6201, PM 8000, PM 9000, VS-800, Datascope Trio, Accutorr V, Passport V	<p>To Monitor:</p>  <p>To Nellcor non-Oximax Sensor:</p> 	7 Foot Adapter	<b>E708-290</b>	0010-20-42594	<b>\$60</b>







## Mindray Adapter Cables (Continued)

Models	Connector	Options	Part Number	OEM #	Price
VS 800, PM 7000, PM 8000, PM 9000 Series and New PM 6000	<p>To Monitor:</p>  <p>To Nellcor non-Oximax Sensor:</p> 	7 Foot Adapter	<b>E708-30M0</b>		<b>\$72</b>
Trio, Mindray PM 7000, PM 9000	<p>To Monitor:</p>  <p>To Nellcor Oximax Sensor:</p> 	10 Foot Adapter	<b>E710P-1800</b>		<b>\$87</b>
	<p>To Monitor:</p>  <p>To Nellcor Oximax Sensor:</p> 	10 Foot Adapter	<b>E710P-1840</b>	0010-20-42595	<b>\$87</b>
VS 800, PM 7000, PM 8000, PM 9000 Series and New PM 6000 with Masimo technology	<p>To Monitor:</p>  <p>To Masimo LNOP Sensor:</p> 	7 Foot Adapter	<b>E708M-29P0</b>	9200-30-10707	<b>\$72</b>
VS 800, PM 7000, PM 8000, PM 9000 Series and New PM 6000 with Masimo technology	<p>To Monitor:</p>  <p>To Masimo LNOP Sensor:</p> 	7 Foot Adapter	<b>E708M-30P0</b>		<b>\$72</b>

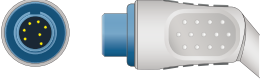
Mindray Adapter Cables (Continued)

Models	Connector	Options	Part Number	OEM #	Price
VS 800, PM 7000, PM 8000, PM 9000 Series and New PM 6000.	<p>To Monitor:</p>  <p>To Masimo LNCS Sensor:</p> 	7 Foot Adapter	<b>E708M-300</b>	0010-30-42625, 9200-30-10682	<b>\$72</b>
MEC-509, 509+, 503, 507	<p>To Monitor:</p>  <p>To Nellcor non-Oximax Sensor:</p> 	7 Foot Adapter	<b>E708-310</b>	512A-30-0607	<b>\$72</b>
PM 5000, PM 6000, PM 8100	<p>To Monitor:</p>  <p>To Nellcor non-Oximax Sensor:</p> 	7 Foot Adapter	<b>E708-220</b>	0010-30-42737, 0010-20-42710	<b>\$60</b>
PM 6000 with Masimo technology	<p>To Monitor:</p>  <p>To Nellcor non-Oximax Sensor:</p> 	7 Foot Adapter	<b>E708-22M0</b>		<b>\$72</b>
PM 6000 with Masimo technology	<p>To Monitor:</p>  <p>To Masimo LNCS Sensor:</p> 	7 Foot Adapter	<b>E708M-220</b>	0010-30-12452	<b>\$72</b>

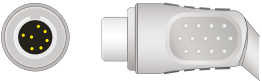
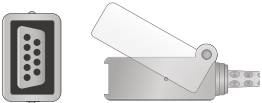
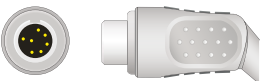
## Mindray Adapter Cables (Continued)

Models	Connector	Options	Part Number	OEM #	Price
BeneView T5, T8, PM 6800 without Oximax and Penlon Intermed Patient Monitors	<p>To Monitor:</p>  <p>To Nellcor non-Oximax Sensor:</p> 	7 Foot Adapter	<b>E708-480</b>	0010-20-42710	<b>\$54</b>
BeneView T5 and T8 with Oximax technology	<p>To Monitor:</p>  <p>To Nellcor Oximax Sensor:</p> 	10 Foot Adapter	<b>E710P-480</b>	0010-20-42712	<b>\$72</b>
T5, T8 and Penlon Intermed patient monitors with Masimo technology	<p>To Monitor:</p>  <p>To Nellcor non-Oximax Sensor:</p> 	7 Foot Adapter	<b>E708-48M0</b>	0010-30-42738	<b>\$72</b>
BeneView T5 and T8	<p>To Monitor:</p>  <p>To Masimo LNCS Sensor:</p> 	7 Foot Adapter	<b>E708M-480</b>	0010-30-42738	<b>\$72</b>

### Nellcor Direct Connect Sensors

Models	Connector	Options	Part Number	OEM #	Price
Datascopes: Accutorr Plus (Nellcor); Invivo: MDE Prism Escort; Nellcor: NPB 290, NPB 295, N 390, N 395, N 3000, N 6000; Nihon Kohden: BSM-4104A, BSM-4114A and Colin Press Mate, Prodigy, BP88/306, BP885		Adult Clip	<b>S410-690</b>		<b>\$112</b>
		Adult Soft	<b>S410S-690</b>		<b>\$112</b>
		Pediatric Clip	<b>S110-690</b>		<b>\$112</b>
		Pediatric Soft	<b>S110S-690</b>		<b>\$112</b>
		Neonate Wrap	<b>S310-690</b>		<b>\$126</b>
		Multi-Site	<b>S810-690</b>		<b>\$126</b>
		Adult Clip	<b>S410-010</b>		<b>\$126</b>
		Adult Soft	<b>S410S-010</b>		<b>\$126</b>
		Pediatric Clip	<b>S110-010</b>		<b>\$126</b>
		Pediatric Soft	<b>S110S-010</b>		<b>\$126</b>
		Neonate Wrap	<b>S310-010</b>		<b>\$137</b>
		Multi-Site	<b>S810-010</b>		<b>\$137</b>

### Nellcor Short Sensors

Models	Connector	Options	Part Number	OEM #	Price
All monitors with Nellcor Oximax SpO2 technology		Adult Clip	<b>S403-01P0</b>	DS100A	<b>\$92</b>
		Adult Soft	<b>S403S-01P0</b>	OXI-A/N	<b>\$92</b>
		Pediatric Clip	<b>S103-01P0</b>	OXI-P/I	<b>\$92</b>
		Pediatric Soft	<b>S103S-01P0</b>		<b>\$92</b>
		Neonate Wrap	<b>S303-01P0</b>		<b>\$96</b>
		Adult Ear Clip	<b>S903-01P0</b>		<b>\$96</b>
		Multi-Site	<b>S803-01P0</b>	D-YS	<b>\$96</b>
Older Oxi-Smart monitors that require sensors without Oximax technology		Adult Clip	<b>S403-010</b>	F-3212-9, 06-00-1074, 512E-30-90390, 512F-30-28263, M1196T, 512D-30-90200, 2023211-001	<b>\$110</b>
		Adult Soft	<b>S403S-010</b>	M1191T, 512E-30-90390	<b>\$110</b>
		Pediatric Clip	<b>S103-010</b>	512G-30-90607, 512H-30-79061, 512H-30-79061	<b>\$110</b>
		Pediatric Soft	<b>S103S-010</b>	M1192T, 512G-30-90607	<b>\$110</b>
		Neonate Wrap	<b>S303-010</b>	M1193T	<b>\$118</b>
		Multi-Site	<b>S803-010</b>	518B-30-7210, 2023215-001, 518B-30-72107	<b>\$118</b>





### Nellcor Disposable Sensors

Models	Connector	Options	Part Number	OEM #	Price
All monitors with Nellcor Oximax technology		Adult Box of 24	<b>S503-01P0</b>	MAX-A, 70124027, MX50065	<b>\$240</b>
		Pediatric Box of 24	<b>S523-01P0</b>	MAX-P, 70124022, MX50066	<b>\$240</b>
		Infant Box of 24	<b>S533-01P0</b>	MAX-I, 70124026, MX50067	<b>\$240</b>
		Neonate Box of 24	<b>S543-01P0</b>	MAX-N, 70124032, MX50068	<b>\$240</b>

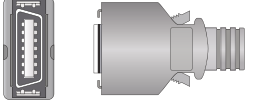
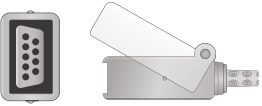
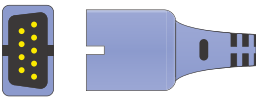

## Nellcor Disposable Sensors (Continued)

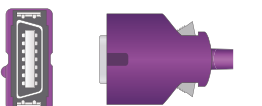
Models	Connector	Options	Part Number	OEM #	Price
Older Oxi-Smart monitors that require sensors without Oximax technology		Adult Box of 24	<b>S503-010</b>	D25, 2023217-001, M1131A	<b>\$216</b>
		Pediatric Box of 24	<b>S523-010</b>	D20	<b>\$216</b>
		Infant Box of 24	<b>S533-010</b>	I20, M1132A	<b>\$216</b>
		Neonate Box of 24	<b>S543-010</b>	N25, 2023216-001, M1133A, M1134A	<b>\$216</b>

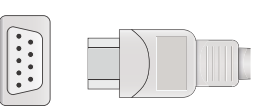

## Nellcor Adapter Cables

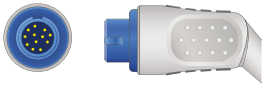
Models	Connector	Options	Part Number	OEM #	Price
Colin: BP88/306; Critikon Dinamap ProCare, Pro Series, Pro 300, Pro 1000, M-NSAT Modules; Datascope: Accutorr Plus, Duo, Passport 2, Passport XG, Spectrum, Trio; Nellcor: NPB-290, NPB-295, N-390, N-395, N-3000, N-6000, NPB-290, NPB-295, N-390, N-395, N-3000, N-6000; Nihon Kohden: BSM-2300, BSM-4100, BSM-5100, BSM-4104A, BSM-4114A; Ohmeda enGuard CMS; Physio Control Lifepak 12	To Monitor:  To Nellcor non-Oximax Sensor: 	7 Foot Adapter	<b>E708-690</b>	SCP-10, MC-10, 200012-00-1254, NK-SCP-10, 0012-00-1254, 903131	<b>\$60</b>
NBP-195; Colin; GE Dinamap Compact Dinamap MPS; All Welch Allyn	To Monitor:  To Nellcor Oximax Sensor: 	4 Foot Adapter	<b>E704-710</b>	DEC-04	<b>\$60</b>
		7 Foot Adapter	<b>E708-710</b>	DEC-08, NON-UNI-EXT-3, EC8	<b>\$60</b>
		10 Foot Adapter	<b>E710-710</b>	DEC-10	<b>\$60</b>
N-595 and N-600; CAS Med 511 Apnea Monitor; Cardell Veterinary 9403, 9500HD; Colin BP-S510 and T105NXM; Digicare LW600; Dinamap Carescape V100, ProCare, Pro Series, ProSeries V2, Pro 300, Pro 1000, Pro 1000 V3, E-NSAT Modules for i4 Modular Monitors with Oximax option; Fukuda Denshi DS-7100; GE Procure; Welch Allyn Spot Vital Signs 42NTB-E1, 42NT0-E1 LXI	To Monitor:  To Nellcor Oximax Sensor: 	10 Foot Adapter	<b>E710-700</b>	DOC-10, WA-DOC-10, 0012-00-1464, 01-02-0183, 2008773-001, 2021406-002	<b>\$72</b>
N-100, N-200, N-1000 and N-2000 Preamp cable; MDE Escort E100, Drager VitAlert 3200	To Monitor:  To Nellcor non-Oximax Sensor: 	10 Foot Adapter	<b>E710-850</b>	M-200-13, C-13-200	<b>\$162</b>

## Newtech Direct Connect Sensors

Models	Connector	Options	Part Number	OEM #	Price
NT3A		Adult Clip	<b>S410-173D0</b>		<b>\$126</b>
		Adult Soft	<b>S410S-173D0</b>		<b>\$126</b>
		Pediatric Clip	<b>S110-173D0</b>		<b>\$126</b>
		Pediatric Soft	<b>S110S-173D0</b>		<b>\$126</b>
		Neonate Wrap	<b>S310-173D0</b>		<b>\$137</b>
		Multi-Site	<b>S810-173D0</b>		<b>\$137</b>
NT2A		Adult Clip	<b>S410-165D0</b>		<b>\$126</b>
		Adult Soft	<b>S410S-165D0</b>		<b>\$126</b>
		Pediatric Clip	<b>S110-165D0</b>		<b>\$126</b>
		Pediatric Soft	<b>S110S-165D0</b>		<b>\$126</b>
		Neonate Wrap	<b>S310-165D0</b>		<b>\$137</b>
		Multi-Site	<b>S810-165D0</b>		<b>\$137</b>

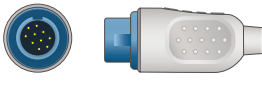
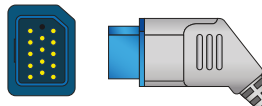
## Nihon Kohden Direct Connect Sensors

Models	Connector	Options	Part Number	OEM #	Price
AL-800PA Module, BSM-1101 Life Scope EC, BSM-2101/2 Life Scope L, BSM-3101 Life Scope LC, BSM-7100/7200 Life Scope 8, BSM-8200/1 Life Scope 12, BSM-8301/2 Life Scope 9, SM-8800 Life Scope 14, OLV-1100A, NT3B		Adult Clip	<b>S410-160</b>		<b>\$126</b>
		Adult Soft	<b>S410S-160</b>		<b>\$126</b>
		Pediatric Clip	<b>S110-160</b>		<b>\$126</b>
		Pediatric Soft	<b>S110S-160</b>		<b>\$126</b>
		Neonate Wrap	<b>S310-160</b>		<b>\$137</b>
		Multi-Site	<b>S810-160</b>		<b>\$137</b>
BSM-4101, BSM-4102, BSM-4102A, 4103, 4111, 4113 Life Scope P, BSM-5105, 5135 Life Scope A, BSM-2351, 2353 Life Scope L, BSM-2301, 2303 Life Scope I, Life Scope J, BSM-9101 and PVM-2701		Adult Clip	<b>S410-360</b>	TL-201T	<b>\$126</b>
		Adult Soft	<b>S410S-360</b>		<b>\$126</b>
		Pediatric Clip	<b>S110-360</b>		<b>\$126</b>
		Pediatric Soft	<b>S110S-360</b>		<b>\$126</b>
		Neonate Wrap	<b>S310-360</b>		<b>\$137</b>
		Multi-Site	<b>S810-360</b>		<b>\$137</b>
		Adult Clip	<b>S410-1060</b>		<b>\$126</b>
		Adult Soft	<b>S410S-1060</b>		<b>\$126</b>
		Pediatric Clip	<b>S110-1060</b>		<b>\$126</b>
		Pediatric Soft	<b>S110S-1060</b>		<b>\$126</b>
		Neonate Wrap	<b>S310-1060</b>		<b>\$137</b>
		Multi-Site	<b>S810-1060</b>		<b>\$137</b>



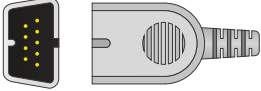

### Nihon Kohden Short Sensors

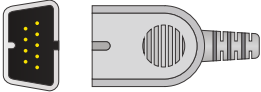
Models	Connector	Options	Part Number	OEM #	Price
BSM-2300 Life Scope I, BSM-2301, MSM 2301K, 2303 Life Scope I, 2303K, BSM 2350 Life Scope L, BSM-2351, 2353 Life Scope L, BSM-4100 Life Scope P, BSM 4101, 4103 TL-101T, 4111, 4113 Life Scope P, BSM-5100 Life Scope A, BSM-5105, 5135 Life Scope A, Life Scope TR, BSM-6000 series, BSM-6301K, BSM-6501K, BSM-6701K, BSM-9510 Life Scope M, BSM-9800 Life Scope S, Oxipal P225F		Adult Clip	<b>S405-160</b>	TL-101T, TL-201T	<b>\$110</b>
		Adult Soft	<b>S405S-160</b>		<b>\$110</b>
		Pediatric Clip	<b>S105-160</b>		<b>\$110</b>
		Pediatric Soft	<b>S105S-160</b>		<b>\$110</b>
		Neonate Wrap	<b>S305-160</b>		<b>\$118</b>
		Multi-Site	<b>S805-160</b>	TL-220T, TL-260T	<b>\$118</b>

### Nihon Kohden Disposable Sensors

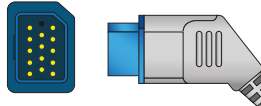
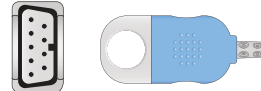
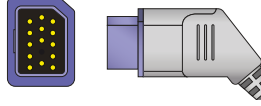
Models	Connector	Options	Part Number	OEM #	Price
		Adult Box of 24	<b>S503-160</b>	TL-251T, TL-271T3	<b>\$216</b>
		Pediatric Box of 24	<b>S523-160</b>	TL-252T, TL-272T3	<b>\$216</b>
		Infant Box of 24	<b>S533-160</b>	TL-252T	<b>\$216</b>
		Neonate Box of 24	<b>S543-160</b>	TL-253T, TL-273T3	<b>\$216</b>

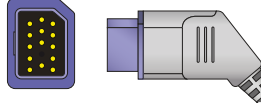
### Nihon Kohden Adapter Cables



Models	Connector	Options	Part Number	OEM #	Price
BSM-2300 Life Scope I, BSM-2301A, BSM-2351, 2353 Life Scope L, BSM-2301, 2303 Life Scope I, BSM-4100 Life Scope P, BSM-4101, 4103, 4111, 4113 Life Scope P, BSM-5100 Life Scope A, BSM-5105, 5135 Life Scope A, Life Scope TR, BSM-6000 series, BSM-6301K, BSM-6501K, BSM-6701K, BSM-9510 Life Scope M, BSM-9800 Life Scope S	<p>To Monitor:</p>  <p>To Nihon Kohden Sensor:</p> 	10 Foot Adapter	<b>E710-360</b>	JL-900P	<b>\$72</b>
BSM-6313, BSM-6333, BSM-6533, BSM-6573, BSM-6733, BSM-6773, BSM-9173	<p>To Monitor:</p>  <p>To Masimo LNCS Sensor:</p> 	10 Foot Adapter	<b>E710M-360</b>	JL-631P	<b>\$249</b>
Life Scope TR, BSM-6000 series, BSM-6310K, BSM-6501K, BSM-6701K and AY-651P and AY-653P modules	<p>To Monitor:</p>  <p>To Nellcor Oximax Sensor:</p> 	10 Foot Adapter	<b>E710P-360</b>	JL-650P	<b>\$144</b>

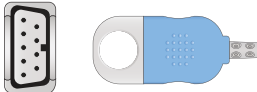

**Nihon Kohden Adapter Cables (Continued)**

Models	Connector	Options	Part Number	OEM #	Price
OPV-1500 Life Scope N	<p>To Monitor:</p>  <p>To Nihon Kohden Sensor:</p> 	10 Foot Adapter	<b>E710-1060</b>	JL-302T	<b>\$84</b>

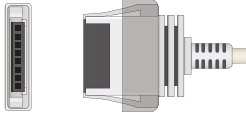
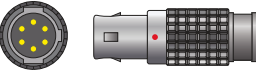
**Nonin Direct Connect Sensors**

Models	Connector	Options	Part Number	OEM #	Price
8600, 8500, 8700, 8800, 96, 009 and 700		Adult Clip	<b>S410-280</b>		<b>\$126</b>
		Adult Soft	<b>S410S-280</b>		<b>\$126</b>
		Pediatric Clip	<b>S110-280</b>		<b>\$126</b>
		Pediatric Soft	<b>S110S-280</b>		<b>\$126</b>
		Neonate Wrap	<b>S310-280</b>		<b>\$137</b>
		Multi-Site	<b>S810-280</b>		<b>\$137</b>
8604, 8604D		Adult Clip	<b>S410-080</b>		<b>\$126</b>
		Adult Soft	<b>S410S-080</b>		<b>\$126</b>
		Pediatric Clip	<b>S110-080</b>		<b>\$126</b>
		Pediatric Soft	<b>S110S-080</b>		<b>\$126</b>
		Neonate Wrap	<b>S310-080</b>		<b>\$137</b>
		Multi-Site	<b>S810-080</b>		<b>\$137</b>
8000 J-3		Adult Clip	<b>S410-08L0</b>		<b>\$126</b>
		Adult Soft	<b>S410S-08L0</b>		<b>\$126</b>
		Pediatric Clip	<b>S110-08L0</b>		<b>\$126</b>
		Pediatric Soft	<b>S110S-08L0</b>		<b>\$126</b>
		Neonate Wrap	<b>S310-08L0</b>		<b>\$137</b>
		Multi-Site	<b>S810-08L0</b>		<b>\$137</b>

**Nonin Short Sensors**

Models	Connector	Options	Part Number	OEM #	Price
2500, 2500A, 2120, 7500, 8500, 8550, 8600, 8700, 8800, 9600, 9700, 9840, Respironics 902M Plus, Lifesense and PureSAT		Adult Clip	<b>S403-080</b>	8000AA, 8000AA-2, 8000AA-3, 01-02-0250, 01-03-0117	<b>\$110</b>
		Adult Soft (Large)	<b>S403S-080</b>	8000SL	<b>\$110</b>
		Pediatric Clip	<b>S103-080</b>	8000AP, 01-03-0121, 01-02-0106	<b>\$110</b>
		Pediatric Soft (Medium)	<b>S103S-080</b>	8000SM	<b>\$110</b>
		Infant Soft (Small)	<b>S203S-080</b>	8000SS	<b>\$110</b>
		Neonate Wrap	<b>S303-080</b>		<b>\$118</b>
		Multi-Site	<b>S803-080</b>		<b>\$118</b>



## Nonin Short Sensors (Continued)

Models	Connector	Options	Part Number	OEM #	Price
Avant 4000 Wearable Digital Pulse Oximetry		Adult Clip	<b>S401-1460</b>	8000AA-WO	<b>\$110</b>
		Adult Soft	<b>S401S-1460</b>	8000J-WO	<b>\$110</b>

## Nonin Disposable Sensors

Models	Connector	Options	Part Number	OEM #	Price
		Adult Box of 24	<b>S503-080</b>	6000CA, 7000A	<b>\$216</b>
		Pediatric Box of 24	<b>S523-080</b>	6000CP, 7000P	<b>\$216</b>
		Infant Box of 24	<b>S533-080</b>	6000CI, 7000I	<b>\$216</b>
		Neonate Box of 24	<b>S543-080</b>	6000CN, 7000N	<b>\$216</b>

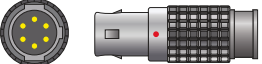
## Nonin Adapter Cables (Also see Nellcor)

Models	Connector	Options	Part Number	OEM #	Price
8604, 8604D	To Monitor:   To Nonin Sensor: 	7 Foot Adapter	<b>E708-080</b>		<b>\$72</b>

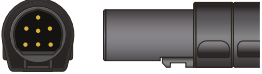

## Novametrix Direct Connect Sensors

Models	Connector	Options	Part Number	OEM #	Price
505, 510, 511, 515, 515A, 515B, 515C, 520, 520A, 7000, 7100, Oxypleth; Spacelabs: 90351-D/G, 90369, 9046, 90466, 90467, 90489, 90651-07/08, 90419-01, 90651A-07		Adult Clip	<b>S410-030</b>	369083-001, 8776-00	<b>\$126</b>
		Adult Soft	<b>S410S-030</b>		<b>\$126</b>
		Pediatric Clip	<b>S110-030</b>		<b>\$126</b>
		Pediatric Soft	<b>S110S-030</b>		<b>\$126</b>
		Neonate Wrap	<b>S310-030</b>		<b>\$137</b>
		Multi-Site	<b>S810-030</b>	8791-00	<b>\$137</b>

## Novametrix Short Sensors

Models	Connector	Options	Part Number	OEM #	Price
505, 510, 511, 512, 513, 515B, 515C, 520, 520A, 7000, 7100, Oxypleth; Spacelabs: 90351-D/G, 90465, 90466, 90467, 90489, 90651-07/08, 90419-01, 90651A-07		Adult clip	<b>S403-030</b>	8776-00, 9768-00	<b>\$110</b>
		Adult soft	<b>S403S-030</b>		<b>\$110</b>
		Pediatric clip	<b>S103-030</b>		<b>\$110</b>
		Pediatric soft	<b>S103S-030</b>		<b>\$110</b>
		Neonate Wrap	<b>S303-030</b>	9168-00	<b>\$118</b>
		Multi-Site	<b>S803-030</b>	9769-00	<b>\$118</b>

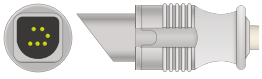

**Novametrix Short Sensors (Continued)**

Models	Connector	Options	Part Number	OEM #	Price
		Adult clip	<b>S403-1030</b>	8744-00	<b>\$110</b>
		Adult soft	<b>S403S-1030</b>		<b>\$110</b>
		Pediatric clip	<b>S103-1030</b>		<b>\$110</b>
		Pediatric soft	<b>S103S-1030</b>		<b>\$110</b>
		Neonate Wrap	<b>S303-1030</b>		<b>\$118</b>
		Multi-Site	<b>S803-1030</b>	8793-00	<b>\$118</b>
Respironics 920, 920M, 920M Plus, Tidal Wave 710Sp, 715Sp. Please note that some Respironics 920 models require a 7-pin connector, for these models please request item S403-08T0		Adult clip	<b>S403-730</b>		<b>\$110</b>
		Adult soft	<b>S403S-730</b>		<b>\$110</b>
		Pediatric clip	<b>S103-730</b>		<b>\$110</b>
		Pediatric soft	<b>S103S-730</b>		<b>\$110</b>
		Neonate Wrap	<b>S303-730</b>		<b>\$118</b>
		Multi-Site	<b>S803-730</b>		<b>\$118</b>

**Novametrix Disposable Sensors**

Models	Connector	Options	Part Number	OEM #	Price
		Adult Box of 24	<b>S503-030</b>	AS110	<b>\$240</b>
		Pediatric Box of 24	<b>S523-030</b>	AS120	<b>\$240</b>
		Infant Box of 24	<b>S533-030</b>	AS120	<b>\$240</b>
		Neonate Box of 24	<b>S543-030</b>	AS140	<b>\$240</b>

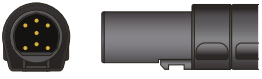
**Novametrix Adapter Cables**

Models	Connector	Options	Part Number	OEM #	Price
	<p>To Monitor:</p>  <p>To Novametrix Sensor:</p> 	7 Foot Adapter	<b>E708-030</b>		<b>\$72</b>



**Pace Tech Direct Connect Sensors**

Models	Connector	Options	Part Number	OEM #	Price
Vitalmax 4000, Vitalmax 4100 without touch screen technology (1st version). The SpO2 connector for these Pace Tech monitors are usually identified with a yellow ring around the connector.		Adult Clip	<b>S410-84D0</b>		<b>\$126</b>
		Adult Soft	<b>S410S-84D0</b>		<b>\$126</b>
		Pediatric Clip	<b>S110-84D0</b>		<b>\$126</b>
		Pediatric Soft	<b>S110S-84D0</b>		<b>\$126</b>
		Neonate Wrap	<b>S310-84D0</b>		<b>\$137</b>
		Multi-Site	<b>S810-84D0</b>		<b>\$137</b>

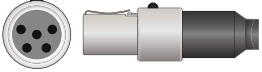
**Pace Tech Direct Connect Sensors (Continued)**

Models	Connector	Options	Part Number	OEM #	Price
Pace Tech monitors with touch-screen technology such as Vitalmax 4000. The SpO2 connector for these Pace Tech monitors are usually identified with a blue/green ring around the connector.		Adult Clip	<b>S410-66D0</b>		<b>\$126</b>
		Adult Soft	<b>S410S-66D0</b>		<b>\$126</b>
		Pediatric Clip	<b>S110-66D0</b>		<b>\$126</b>
		Pediatric Soft	<b>S110S-66D0</b>		<b>\$126</b>
		Neonate Wrap	<b>S310-66D0</b>		<b>\$137</b>
		Multi-Site	<b>S810-66D0</b>		<b>\$137</b>
Pace Tech Model 520, with black face except for Vitalmax 800w Nellcor		Adult Clip	<b>S410-390</b>		<b>\$126</b>
		Adult Soft	<b>S410S-390</b>		<b>\$126</b>
		Pediatric Clip	<b>S110-390</b>		<b>\$126</b>
		Pediatric Soft	<b>S110S-390</b>		<b>\$126</b>
		Neonate Wrap	<b>S310-390</b>		<b>\$137</b>
		Multi-Site	<b>S810-390</b>		<b>\$137</b>

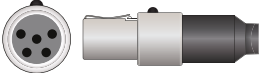
**Pace Tech Adapter Cables**

Models	Connector	Options	Part Number	OEM #	Price
	<p>To Monitor:</p>  <p>To Nellcor non-Oximax Sensor:</p> 	7 Foot Adapter	<b>E708-390</b>		<b>\$72</b>

**Palco Direct Connect Sensors**

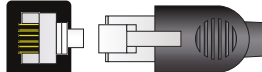
Models	Connector	Options	Part Number	OEM #	Price
		Adult Clip	<b>S410-180</b>		<b>\$126</b>
		Adult Soft	<b>S410S-180</b>		<b>\$126</b>
		Pediatric Clip	<b>S110-180</b>		<b>\$126</b>
		Pediatric Soft	<b>S110S-180</b>		<b>\$126</b>
		Neonate Wrap	<b>S310-180</b>		<b>\$137</b>
		Multi-Site	<b>S810-180</b>		<b>\$137</b>

### Philips Direct Connect Sensors

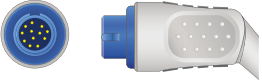
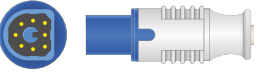
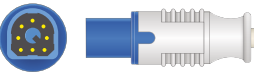
Models	Connector	Options	Part Number	OEM #	Price
78352A, 78352C, 78354A, 78354C, 78834C, M1020A, M1025A, M1025B, M1092A, M1094B, M1204A, M1205A, M1350B, M1722A, M1722B, M1190A, M1723A, M1723B, M1732A, M1732B, M2475B, M3046A M4, V24E, Codemaster, HeartStart XL, Agilent 50XM Fetal Monitor		Adult Clip	<b>S410-200</b>	M1190A	<b>\$126</b>
		Adult Soft	<b>S410S-200</b>		<b>\$126</b>
		Pediatric Clip	<b>S110-200</b>		<b>\$126</b>
		Pediatric Soft	<b>S110S-200</b>		<b>\$126</b>
		Neonate Wrap	<b>S310-200</b>		<b>\$137</b>
		Multi-Site	<b>S810-200</b>		<b>\$137</b>
C1, C3, M3, M4, MP20, MP30, MP40, MP50, MP60, MP70, MP80, MP90, VM4, VM6, VM8, HP Viridia 24C, Philips HeartStart defibrillator and IntelliVue; Goldway G40; Solaris NT2A, NT2C		Adult Clip	<b>S410-910</b>	M1196A	<b>\$126</b>
		Adult Soft	<b>S410S-910</b>	M1191AL, M1191BL	<b>\$126</b>
		Pediatric Clip	<b>S110-910</b>		<b>\$126</b>
		Pediatric Soft	<b>S110S-910</b>		<b>\$126</b>
		Neonate Wrap	<b>S310-910</b>		<b>\$137</b>
		Adult Ear Clip	<b>S910-910</b>		<b>\$126</b>
MP20, MP30, MP40, MP50, MP60, MP70, MP90, VN4, VN6, VN8 with Masimo technology		Adult Clip	<b>S410-91M0</b>		<b>\$126</b>
		Adult Soft	<b>S410S-91M0</b>		<b>\$126</b>
		Pediatric Clip	<b>S110-91M0</b>		<b>\$126</b>
		Pediatric Soft	<b>S110S-91M0</b>		<b>\$126</b>
		Neonate Wrap	<b>S310-91M0</b>		<b>\$137</b>
		Multi-Site	<b>S810-91M0</b>		<b>\$137</b>



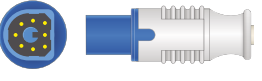



### Philips Short Sensors

Models	Connector	Options	Part Number	OEM #	Price
Viridia 24C, C1, C3, M3, M4, MP20, MP30, MP40, MP50, MP60, MP70, MP80, MP90, VM4, VM6, VM8, HeartStart MRx and SureSigns VS3		Adult clip	<b>S403-910</b>		<b>\$110</b>
		Adult soft	<b>S403S-910</b>	M1191A, M1191B, M4531A, 989803109321	<b>\$110</b>
		Pediatric clip	<b>S103-910</b>		<b>\$110</b>
		Pediatric soft	<b>S103S-910</b>	M1192A	<b>\$110</b>
		Infant soft	<b>S203S-910</b>	M1195A	<b>\$110</b>
		Neonate Wrap	<b>S303-910</b>	M1193A	<b>\$118</b>
		Adult Ear Clip	<b>S903-910</b>	M1194A	<b>\$110</b>
		Multi-Site	<b>S803-910</b>		<b>\$118</b>

Philips Adapter Cables

Models	Connector	Options	Part Number	OEM #	Price
Heartstream XL, IntelliVue MP70, M2601A, M3000A, M3500B, M4735A, M1020B, M3000A/M3001A MMS, M3002A MMS X2, M8102A MP2, M8105A MPS	<p>To Monitor:</p>  <p>To Nellcor non-Oximax Sensor:</p> 	7 Foot Adapter	<b>E708-430</b>	M1943AL, TE1514, 989803128651	<b>\$72</b>
	<p>To Monitor:</p>  <p>To Nellcor Oximax Sensor:</p> 	10 Foot Adapter	<b>E710P-430</b>	M1943NL	<b>\$72</b>
M2601A, M3000A, M3500 B, M4735A	<p>To Monitor:</p>  <p>To Philips Sensor:</p> 	7 Foot Adapter	<b>E708-410</b>	M1941A, M1941B	<b>\$72</b>
	<p>To Monitor:</p>  <p>To Nellcor non-Oximax Sensor:</p> 	7 Foot Adapter	<b>E708-43M0</b>		<b>\$72</b>
Philips IntelliVue FAST-SpO2	<p>To Monitor:</p>  <p>To Masimo LNOP Sensor:</p> 	7 Foot Adapter	<b>E708M-43P0</b>	LNOP MP12, 2282, M1020-61100	<b>\$84</b>



**Philips Adapter Cables (Continued)**

Models	Connector	Options	Part Number	OEM #	Price
SureSigns VS3	<p>To Monitor:</p>  <p>To Masimo LNCS Sensor:</p> 	7 Foot Adapter	<b>E708M-430</b>	LNC MP10, 2281, 9898031 48221	<b>\$72</b>
78352C, 78354C, 78834C, M1020A, M1025B, M1205A, M1350, M1722A/B, M1732A/B, M2475B, Viridia A1, Viridia A3	<p>To Monitor:</p>  <p>To Nellcor non-Oximax Sensor:</p> 	7 Foot Adapter	<b>E708-200</b>	M1900A, M1900B	<b>\$72</b>
M1020A, M2475B, M1732A/B, M1722A/B, M1020A, 78833C, 78833A, 78834A, 78352C, 78352A	<p>To Monitor:</p>  <p>To Philips Sensor:</p> 	7 Foot Adapter	<b>E708-400</b>	M1940A, M1940B	<b>\$72</b>





**Physio Control** (See Masimo and Nellcor Adapter Cables)

**Respironics** (See Novamatrix Short Sensors)

**Schiller Direct Connect Sensors**

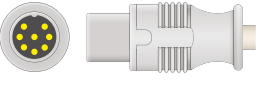

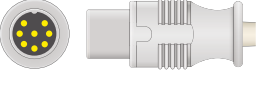
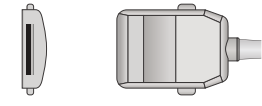
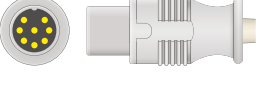
Models	Connector	Options	Part Number	OEM #	Price
Argus CM8, SM783, SM784, SM785, TM910		Adult Clip	<b>S410-170</b>		<b>\$126</b>
		Adult Soft	<b>S410S-170</b>		<b>\$126</b>
		Pediatric Clip	<b>S110-170</b>		<b>\$126</b>
		Pediatric Soft	<b>S110S-170</b>		<b>\$126</b>
		Neonate Wrap	<b>S310-170</b>		<b>\$137</b>
		Multi-Site	<b>S810-170</b>		<b>\$137</b>
TM7, Argus Pro, Argus LCM with Masimo technology		Adult Clip	<b>S410-17M0</b>		<b>\$126</b>
		Adult Soft	<b>S410S-17M0</b>		<b>\$126</b>
		Pediatric Clip	<b>S110-17M0</b>		<b>\$126</b>
		Pediatric Soft	<b>S110S-17M0</b>		<b>\$126</b>
		Neonate Wrap	<b>S310-17M0</b>		<b>\$137</b>
		Multi-Site	<b>S810-17M0</b>		<b>\$137</b>

**Schiller Adapter Cables**

Models	Connector	Options	Part Number	OEM #	Price
Argus TM-7	To Monitor:  To Nellcor non-Oximax Sensor: 	7 Foot Adapter	<b>E708-17M0</b>		<b>\$60</b>
	To Monitor:  To Masimo LNOP Sensor: 	7 Foot Adapter	<b>E708M-17P0</b>		<b>\$72</b>
Also for use as Welch Allyn interface cable	To Monitor:  To Masimo LNCS Sensor: 	7 Foot Adapter	<b>E708M-170</b>	008-0692-02	<b>\$195</b>

**Siemens** (See Drager)

**Spacelabs Direct Connect Sensors** (Also see Novamatrix)

Models	Connector	Options	Part Number	OEM #	Price
90351-0/6, 90309, 90465, 0466, 90489, 90651-A, IM77, 90308, PC Scout		Adult Clip	<b>S410-040</b>	90651A-08, 015-0130-00, 015-0130-01	<b>\$126</b>
		Adult Soft	<b>S410S-040</b>		<b>\$126</b>
		Pediatric Clip	<b>S110-040</b>		<b>\$126</b>
		Pediatric Soft	<b>S110S-040</b>		<b>\$126</b>
		Neonate Wrap	<b>S310-040</b>		<b>\$137</b>
		Multi-Site	<b>S810-040</b>		<b>\$137</b>
1050, 1600, 1700, 90367, 90369, 90469, 90496, Ultraview, 91220, 91369, mCare 300 with Nellcor technology		Adult Clip	<b>S410-740</b>	SP-015-0660-00	<b>\$126</b>
		Adult Soft	<b>S410S-740</b>		<b>\$126</b>
		Pediatric Clip	<b>S110-740</b>		<b>\$126</b>
		Pediatric Soft	<b>S110S-740</b>		<b>\$126</b>
		Neonate Wrap	<b>S310-740</b>		<b>\$137</b>
		Multi-Site	<b>S810-740</b>		SP-015-0661-00



Spacelabs Adapter Cables

Models	Connector	Options	Part Number	OEM #	Price
90303B, 90351-0/6, 90465, 0466, 90489, 90651A-08, 90651-A, IM77, 90308, Scout	<p>To Monitor:</p>  <p>To Nellcor non-Oximax Sensor:</p> 	7 Foot Adapter	<b>E708-040</b>	700-0002-00	<b>\$60</b>
	<p>To Monitor:</p>  <p>To Nellcor non-Oximax Sensor:</p> 	7 Foot Adapter	<b>E708-740</b>	700-0030-00	<b>\$72</b>
1050, 1600, 1700, 90369, 90469, 91220-B, 904, 96, Ultraview and Ultraview SL with Oximax technology	<p>To Monitor:</p>  <p>To Nellcor non-Oximax Sensor:</p> 	10 Foot Adapter	<b>E710-74P0</b>	700-0792-00, 2021	<b>\$72</b>
	<p>To Monitor:</p>  <p>To Masimo LNOP Sensor:</p> 	7 Foot Adapter	<b>E708M-74P0</b>	700-0789-00, 700-0789-01	<b>\$72</b>
	<p>To Monitor:</p>  <p>To Masimo LNCS Sensor:</p> 	7 Foot Adapter	<b>E708M-740</b>	700-0906-00, 2432 LNC-SL-10	<b>\$72</b>

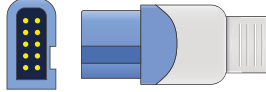
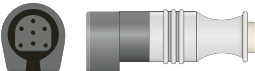
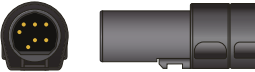
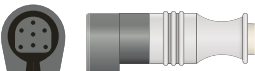

**Spacelabs Adapter Cables** (Continued)

Models	Connector	Options	Part Number	OEM #	Price
Novametrix 90496, 91496-U	<p>To Monitor:</p>  <p>To Novametrix Sensor:</p> 	1 Foot Adapter	<b>E701-74NV0</b>	700-0029-00	<b>\$72</b>
Novametrix 90351D, 90351-G, 90465, 90466, 90467, 90489, 90651-08	<p>To Monitor:</p>  <p>To Novametrix Sensor:</p> 	1 Foot Adapter	<b>E701-04NV0</b>	175-0646-00	<b>\$72</b>

**Takaoka Direct Connect Sensors**

Models	Connector	Options	Part Number	OEM #	Price
9504, 9504 ECG, Oxipani and Oxifast		Adult Clip	<b>S410-990</b>		<b>\$126</b>
		Adult Soft	<b>S410S-990</b>		<b>\$126</b>
		Pediatric Clip	<b>S110-990</b>		<b>\$126</b>
		Pediatric Soft	<b>S110S-990</b>		<b>\$126</b>
		Neonate Wrap	<b>S310-990</b>		<b>\$137</b>
		Multi-Site	<b>S810-990</b>		<b>\$137</b>

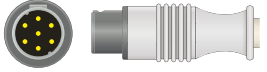
**Welch Allyn Adapter Cables** (Also See Nellcor and Schiller Adapter Cables)

Models	Connector	Options	Part Number	OEM #	Price
PIC 30, PIC 40 and PIC 50 with Oximax technology	<p>To Monitor:</p>  <p>To Nellcor non-Oximax Sensor:</p> 	4 Foot Adapter	<b>E704P-1040</b>	001966-E	<b>\$72</b>

**Zoll** (See Masimo and Nellcor)

## SpO2 Adult Ear Clip

Description	Image	Part Number	OEM #	Price
Attachment for Multi-Sites to apply pulseox sensor on an adult ear lobe.		<b>UEC-010</b>	D-YSE	<b>\$10</b>

## Vet SpO2 Clip Ear/Tongue Small

Description	Image	Part Number	OEM #	Price
Attachment for Multi-Sites to apply pulseox sensor on small animal (such as dogs, cats) for application on tongue or ear.		<b>UVC-020</b>		<b>\$16</b>

## Vet SpO2 Clip Ear/Tongue Large

Description	Image	Part Number	OEM #	Price
Attachment for Multi-Sites to apply pulseox sensor on large animal tongue or ear (lions, bears).		<b>UVC-010</b>		<b>\$20</b>

View full-color photographs of every accessory listed in our catalog. Visit [www.CablesandSensors.com](http://www.CablesandSensors.com) and search by part number.



# ECG

Compatible patient cables with 3 and 5 leads, snap or clip (grabber)



# Choosing your ECG patient cable



## **3 Leads Snap**

Basic trace reading, stronger connection to electrode press stud.



## **3 Leads Clip (Grabber)**

Easy connection to electrode pad without pressing on patient.



## **5 Leads Snap**

Additional traces, press-on snaps provide secure connection reducing false readings.



## **5 Leads Clip (Grabber)**

Additional traces, fast and easy application to electrode pad.

**AAMI One Piece ECG Cables**

Models	Connector	Options	Part Number	OEM #	Price
All monitor models that require the universal 6-pin round connector		3 Leads Snap	<b>C2340S0</b>	852, 853, 1073/S, 9-10418-02, 8000-0025-02, 9500-0029	<b>\$76</b>
		3 Leads Clip	<b>C2340P0</b>	854, 1075/S, 8000-1005-01	<b>\$76</b>
		5 Leads Snap	<b>C2540S0</b>	854, 1075/S, 8000-1005-01	<b>\$95</b>
		5 Leads Clip	<b>C2540P0</b>	1075/P	<b>\$95</b>

**Air Shields** (See AAMI and S&W Artema)

**BCI** (See AAMI)

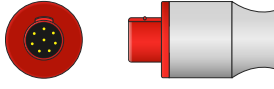

**Bionet One Piece ECG Cables**

Models	Connector	Options	Part Number	OEM #	Price
BM3		3 Leads Snap	<b>C2314S0</b>		<b>\$152</b>
		3 Leads Clip	<b>C2314P0</b>		<b>\$152</b>
		5 Leads Snap	<b>C2514S0</b>		<b>\$152</b>
		5 Leads Clip	<b>C2514P0</b>		<b>\$152</b>

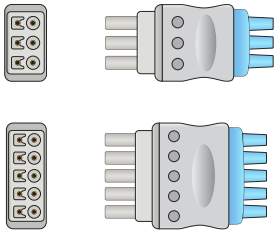
**Bionet ECG Leads**

Models	Connector	Options	Part Number	OEM #	Price
BM3		3 Leads Snap	<b>LBN3-90S0</b>		<b>\$73</b>
		3 Leads Clip	<b>LBN3-90P0</b>		<b>\$73</b>
		5 Leads Snap	<b>LBN5-90S0</b>		<b>\$95</b>
		5 Leads Clip	<b>LBN5-90P0</b>		<b>\$98</b>

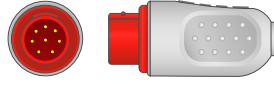
**Bionet ECG Trunk Cables**

Models	Connector	Options	Part Number	OEM #	Price
BM3	To Monitor: 	3 Leads	<b>TN-23140</b>		<b>\$116</b>
		5 Leads	<b>TN-25140</b>		<b>\$116</b>
	To 3 Leads Set: 				
	To 3 Leads Set: 				



**Burdick One Piece ECG Cables** (Also see AAMI)

Models	Connector	Options	Part Number	OEM #	Price
CS615, CS625A, CS520, CS523, CS527, CS57200, EK1, EK2, EK3, EK4, EK5/A/AS, EK8SS, M200, Medic 1, Medic 2, Medic 3, Medic 4, Medic 5, PA-100, PA-104, PA-105, 1600, 2100		3 Leads Snap	<b>C2305S0</b>		<b>\$68</b>
		3 Leads Clip	<b>C2305P0</b>		<b>\$76</b>
		5 Leads Snap	<b>C2505S0</b>		<b>\$84</b>
		5 Leads Clip	<b>C2505P0</b>		<b>\$84</b>

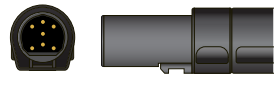
**CAS Med One Piece ECG Cables**

Models	Connector	Options	Part Number	OEM #	Price
511 Apnea Monitor		3 Leads Snap	<b>C2339S0</b>		<b>\$125</b>
		3 Leads Clip	<b>C2339P0</b>		<b>\$125</b>
CAS Med 750 patient monitor		3 Leads Snap	<b>C2364S0</b>	01-02-0304 + 01-02-0308	<b>\$95</b>
		3 Leads Clip	<b>C2364P0</b>	01-02-0304 + 01-02-0350	<b>\$95</b>

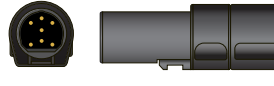
**CAS Med ECG Trunk Cables**

Models	Connector	Options	Part Number	OEM #	Price
CAS Med 750. For use with DIN-style safety leadwires.	To Monitor:   To 3 Leads DIN Set: 	3 Leads	<b>T-13640</b>	01-02-0304	<b>\$76</b>

**Colin One Piece ECG Cables** (Also see AAMI)

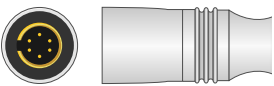
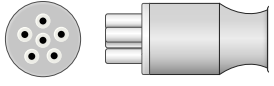
Models	Connector	Options	Part Number	OEM #	Price
BP88 and BP306		3 Leads Snap	<b>C2321S0</b>		<b>\$125</b>
		3 Leads Clip	<b>C2321P0</b>		<b>\$129</b>
BP88S and Colin Press Mate Advantage		3 Leads Snap	<b>C2320S0</b>	MC039-55	<b>\$122</b>
		3 Leads Clip	<b>C2320P0</b>		<b>\$122</b>
		5 Leads Snap	<b>C2520S0</b>		<b>\$122</b>
		5 Leads Clip	<b>C2520P0</b>		<b>\$125</b>

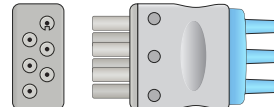

**Colin ECG Leads** (Also see AAMI)

Models	Connector	Options	Part Number	OEM #	Price
All Colin systems		3 Leads Snap	<b>LCL3-90S0</b>		<b>\$84</b>
		3 Leads Clip	<b>LCL3-90P0</b>		<b>\$84</b>
		5 Leads Snap	<b>LCL5-90S0</b>		<b>\$98</b>
		5 Leads Clip	<b>LCL5-90P0</b>		<b>\$98</b>

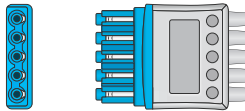
**Criticare ECG Leads** (Also see AAMI)

Models	Connector	Options	Part Number	OEM #	Price
		3 Leads Snap	<b>LGA3-90S0</b>	1124-A3	<b>\$98</b>
		3 Leads Clip	<b>LGA3-90P0</b>		<b>\$98</b>

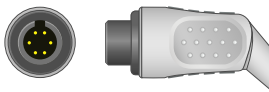
**Criticare ECG Trunk Cables** (Also see AAMI)

Models	Connector	Options	Part Number	OEM #	Price
	To Monitor:   To 3 Leads Set: 	3 Leads	<b>TGA-25400</b>	1123	<b>\$99</b>

**Datascope One Piece ECG Cables**

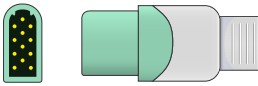
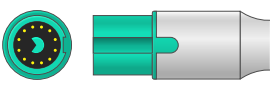



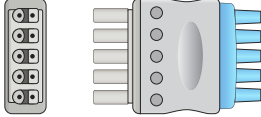
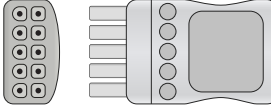

Models	Connector	Options	Part Number	OEM #	Price
Datascope 2000, 2000A, 2001, 2002, 2100, 2200, 3000, 3000A, Ballon Pump, M/D3, M/D3A, M/D4, Passport, Passport IL, Passport EL, Passport XG, Passport XL, Passport 2, Passport 2LT, Passport 5L, Trio, Spectrum, Spectrum OR, System 82, System 83, System 90, System 90T, System 96 and System 97		3 Leads Snap	<b>C2345S0</b>	0131-00-0079, 0012-00-1054-02	<b>\$76</b>
		3 Leads Clip	<b>C2345P0</b>		<b>\$76</b>
		5 Leads Snap	<b>C2540S0</b>		<b>\$95</b>
		5 Leads Clip	<b>C2540P0</b>		<b>\$95</b>
Datascope Passport V, V12 and V21		3 Leads Snap	<b>C2326S0</b>		<b>\$76</b>
		3 Leads Clip	<b>C2326P0</b>		<b>\$76</b>
		5 Leads Snap	<b>C2526S0</b>		<b>\$95</b>
		5 Leads Clip	<b>C2526P0</b>		<b>\$95</b>
Mindray Datascope Expert and Fukuda Denshi Dynascope DS-5100, DS-5100E, DS-5300W, DS-5400, DS-7001		3 Leads Snap	<b>C2359S0</b>		<b>\$76</b>
		3 Leads Clip	<b>C2359P0</b>		<b>\$76</b>
		5 Leads Snap	<b>C2559S0</b>		<b>\$95</b>
		5 Leads Clip	<b>C2559P0</b>		<b>\$95</b>

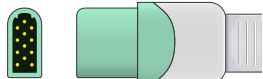

**Datascope ECG Leads**

Models	Connector	Options	Part Number	OEM #	Price
Expert, Passport 2, Passport 2LT, Passport XG, Spectrum, Trio; Mindray PM 5000, PM 6000, BeneView T5 and BeneView T8		3 Leads Snap	<b>LR3-90S0</b>	0012-00-1261-07, 0012-00-1261-08, 0012-00-1261-09	<b>\$65</b>
		3 Leads Clip	<b>LR3-90P0</b>	0012-00-1262-07, 0012-00-1262-08, 0012-00-1262-09	<b>\$65</b>
		5 Leads Snap	<b>LR5-90S0</b>	0012-00-1261-01, 0010-30-42735, 0012-00-1261-02, 0012-00-1261-03	<b>\$68</b>
		5 Leads Clip	<b>LR5-90P0</b>	0012-00-1262-01, 0012-00-1262-02, 0012-00-1262-03	<b>\$68</b>
Panorama, Panorama Telepack 608, Passport 2, Passport V, Spectrum, Spectrum OR, V12, V21 Mobility leadwires		3 Leads Snap	<b>LDT3-90S0</b>	0012-00-1503-04, 0012-00-1503-05, 0012-00-1503-06	<b>\$65</b>
		3 Leads Clip	<b>LDT3-90P0</b>		<b>\$65</b>
		5 Leads Snap	<b>LDT5-90S0</b>	0012-00-1503-01, 0012-00-1503-02, 0012-00-1503-03	<b>\$68</b>
		5 Leads Clip	<b>LDT5-90P0</b>		<b>\$68</b>

**Datascope ECG Trunk Cables**

Models	Connector	Options	Part Number	OEM #	Price
2000, 2001, 2002, 2100, 2200, 3000, 3000A, Balloon Pump, M/D3 with Leads, M/D3A, M/D4, Passport, Passport IL, Passport XG, Passport XL, Passport 2, Passport 2LT, Spectrum System 90, System 90T, System 96, System 97	To Monitor:  To 3 / 5 Leads Set: 	3 / 5 Leads	<b>TR-25400</b>	0012-00-1255-01, 0012-00-1255-02, 0012-00-1255-03, 0012-00-1255-04, 0012-00-1255-05, 0012-00-1255-06	<b>\$78</b>
Datascope Passport V, V12, V21. For use with Datascope Mobility Lead Set.	To Monitor:  To 3 / 5 Leads Set: 	3 / 5 Leads	<b>TT-25260</b>	0012-00-1745-01, 0012-00-1745-02	<b>\$78</b>
For use with Datascope V-Series / Panorama telemetry leadwires on bedside monitors including Datascope Passport 2, Spectrum and other bedside monitors	To Monitor:  To 3 / 5 Leads Set: 	3 / 5 Leads	<b>TT-25400</b>	0012-00-1502-01	<b>\$78</b>

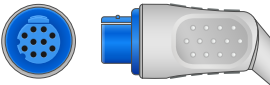

**Datex Ohmeda One Piece ECG Cables**

Models	Connector	Options	Part Number	OEM #	Price
AS/3, AS/3 Compact, CS/3, S/5, S/5 Compact, Cardiocap 1, Cardiocap 2, Cardiocap 5, Light Monitor, Satellite Plus S/5, Aespire		3 Leads Snap	<b>C2395S0</b>		<b>\$99</b>
		3 Leads Clip	<b>C2395P0</b>		<b>\$103</b>
		5 Leads Snap	<b>C2595S0</b>		<b>\$110</b>
		5 Leads Clip	<b>C2595P0</b>		<b>\$114</b>

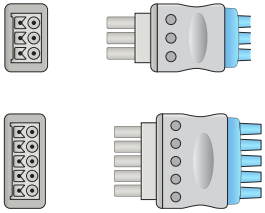
## Datex Ohmeda ECG Leads

Models	Connector	Options	Part Number	OEM #	Price
Equipment with ASP connector for Datex Ohmeda, GE, Pro 1000, AS/3, CS/3, Cardiocap II, Cardiocap 5, Satellite Plus S/5		3 Leads Snap	<b>LX3-90S0</b>	545327-HEL, 545315	<b>\$67</b>
		3 Leads Clip	<b>LX3-90P0</b>	545317-HEL, 8001958	<b>\$70</b>
		5 Leads Snap	<b>LX5-90S0</b>	545328	<b>\$72</b>
		5 Leads Clip	<b>LX5-90P0</b>	545318, 545326, 8001959-HEL	<b>\$72</b>

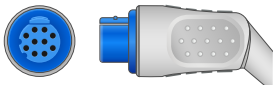

## Datex Ohmeda ECG Trunk Cables

Models	Connector	Options	Part Number	OEM #	Price
AS/3, CS/3, S/5, Cardiocap 1, Cardiocap 2, Cardiocap 5, Light Monitor and Satellite Plus S/5	<p>To Monitor:</p>  <p>To 3 Leads Set:</p>  <p>To 5 Leads Set:</p> 	3 Leads	<b>TX-23950</b>	545307, 545302	<b>\$72</b>
		5 Leads	<b>TX-25950</b>	545303	<b>\$75</b>

## DIN Leads ECG Leads

Models	Connector	Options	Part Number	OEM #	Price
Din-Style Safety Leadwires		3 Leads Snap	<b>L3-90S0</b>	0012-00-1255-09, 0012-00-1262-08, 012-0295-00, 012-0283-00, M3915A	<b>\$17</b>
		3 Leads Clip	<b>L3-90P0</b>	012-0296, 012-0284-00	<b>\$20</b>
		5 Leads Snap	<b>L5-90S0</b>	012-0285-00, 012-0285-01, 012-0605-00	<b>\$28</b>
		5 Leads Clip	<b>L5-90P0</b>	012-0286-00, 012-0286-01, 012-0286-02	<b>\$31</b>

## DIN Leads ECG Trunk Cables

Models	Connector	Options	Part Number	OEM #	Price
DIN Safety Leadwires Trunk Cable	<p>To Monitor:</p>  <p>To 3 Leads Set:</p>  <p>To 5 Leads Set:</p> 	3 Leads	<b>T-23400</b>	0012-00-0991-01, 0012-00-0991-03, 1094/3, 012-0108-01, 012-0201-00	<b>\$50</b>
		5 Leads	<b>T-25400</b>	1094/5, 012-0107-01	<b>\$53</b>



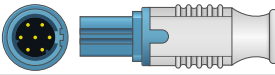
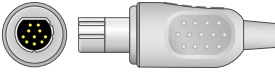

## Dräger One Piece ECG Cables (Also see Siemens)

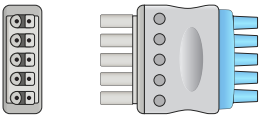
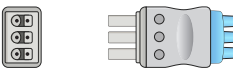
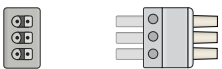
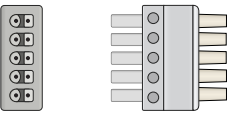
Models	Connector	Options	Part Number	OEM #	Price
SC5000, SC6000, SC7000, SC8000, SC9000		3 Leads Snap	<b>C2323S0</b>		<b>\$114</b>
		3 Leads Clip	<b>C2323P0</b>		<b>\$114</b>
UM1, UM3, UM3.1, RM1, PM8010, PM8014, Babyguard 8000, Cato, PB8800, PM8060; Series 8000, Cicero, Parameterbox		3 Leads Snap	<b>C2377S0</b>	M35367	<b>\$114</b>
		3 Leads Clip	<b>C2377P0</b>		<b>\$114</b>

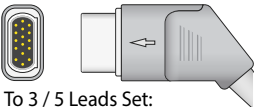

## Dräger ECG Leads

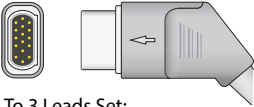
Models	Connector	Options	Part Number	OEM #	Price
For use with MultiMed Pod cable for use with Dräger Infinity Vista, Vista, XL, Delta, Delta XL, Gamma, Gamma XL, Gamma X XL, Kappa, Kappa XLT, Siemens 6000, 7000, 9000		3 Leads Snap	<b>LMB3-90S0</b>	5956441	<b>\$56</b>
		3 Leads Clip	<b>LMB3-90P0</b>		<b>\$56</b>
		5 Leads Snap	<b>LM5-90S0</b>		<b>\$78</b>
		5 Leads Clip	<b>LM5-90P0</b>	5956458, 5956359	<b>\$78</b>
SC5000, SC6000, SC7000, SC8000, SC9000		3 Leads Snap	<b>LM3-90S0</b>		<b>\$78</b>
		3 Leads Clip	<b>LM3-90P0</b>		<b>\$78</b>
Dräger PM8060, Vitara, Parameterbox, Julian		3 Leads Clip	<b>LMD3-90RP0</b>	M35361	<b>\$72</b>
		5 Leads Clip	<b>LMD5-90RP0</b>	M35363	<b>\$72</b>
For use with Dräger, MultiMed Plus, MultiMed Plus OR, and to Infinity M300 and Infinity M540 patient monitors		3 Leads Snap	<b>LG3-90S0</b>		<b>\$62</b>
		3 Leads Clip	<b>LG3-90P0</b>	MS16231	<b>\$64</b>
		5 Leads Snap	<b>LG5-90S0</b>		<b>\$87</b>
		5 Leads Clip	<b>LG5-90P0</b>	MS16546	<b>\$87</b>
		6 Leads Snap	<b>LG6-90S0</b>		<b>\$89</b>
		6 Leads Clip	<b>LG6-90P0</b>	MS16547	<b>\$89</b>

## Dräger ECG Trunk Cables (Also see Siemens)

Models	Connector	Options	Part Number	OEM #	Price
For use with MultiMed Pod for Dräger Infinity Vista, Vista XL, Delta, Delta XL, Gamma, Gamma XL, Gamma X XL, Kappa, Kappa XLT and Siemens 6000, 7000, 9000	To Monitor:  To 3 / 5 Leads Set: 	5 Leads, 2.5m	<b>TM-STE50</b>	3368391, 5950196	<b>\$254</b>
MultiMed® Plus Pod for 3, 5 or 6 leads, respiration, one temperature and SpO2 for use with the following monitors: Draeger Infinity Vista, Vista XL, Delta, Delta XL, Gamma, Gamma XL, Gamma X XL, Kappa, and Kappa XL	To Monitor:  To 3 Leads Set: 	3, 5, 6 Leads	<b>TG-STE60</b>	MS20093	<b>\$299</b>

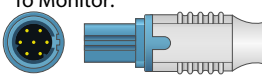

**Drager ECG Trunk Cables (Continued)**

Models	Connector	Options	Part Number	OEM #	Price
SC5000, SC6000, SC7000, SC8000, SC9000	To Monitor:  To 3 Leads Set: 	3 Leads	<b>TM-23230</b>		<b>\$116</b>

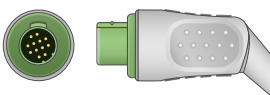
**Fukuda Denshi One Piece ECG Cables (Also see Datascope and Drager)**

Models	Connector	Options	Part Number	OEM #	Price
		5 Leads Snap	<b>C2599S0</b>		<b>\$95</b>
		5 Leads Clip	<b>C2599P0</b>		<b>\$95</b>
		10 Leads Snap	<b>C21099S0</b>		<b>\$99</b>
		10 Leads Clip	<b>C21099P0</b>		<b>\$99</b>

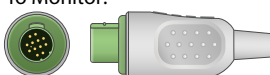
**Fukuda Denshi ECG Trunk Cables (Also see Datascope and Drager)**

Models	Connector	Options	Part Number	OEM #	Price
	To Monitor:  To 5 Leads Set:  To 10 Leads Set: 	5 Leads	<b>TM-25990</b>		<b>\$89</b>
		10 Leads	<b>TQ-210990</b>		<b>\$99</b>



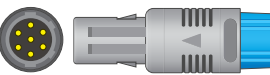

**GE Ultrasound One Piece ECG Cables**

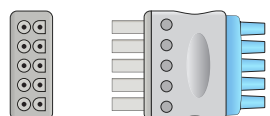
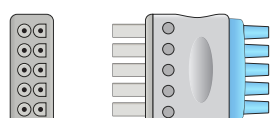
Models	Connector	Options	Part Number	OEM #	Price
GE Vivid i, Vivid q Ultrasound		3 Leads Snap	<b>C2382S0</b>		<b>\$290</b>
		3 Leads Clip	<b>C2382P0</b>	2418831-2	<b>\$290</b>

**GE Ultrasound ECG Leads**

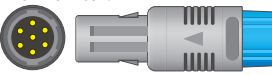
Models	Connector	Options	Part Number	OEM #	Price
GE Vivid i, Vivid q ultrasound systems		3 Leads Snap	<b>LQA3-90S0</b>		<b>\$98</b>
		3 Leads Clip	<b>LQA3-90P0</b>	S2424557	<b>\$98</b>
GE Logiq P6 and P6 Pro ultrasound systems		3 Leads Snap	<b>LQB3-90S0</b>		<b>\$180</b>
		3 Leads	<b>LQB3-90P0</b>		<b>\$180</b>

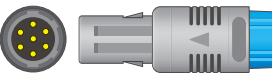
### GE Ultrasound ECG Trunk Cables



Models	Connector	Options	Part Number	OEM #	Price
GE Vivid i, Vivid q Ultrasound	<p>To Monitor:</p>  <p>To 3 Leads Set:</p> 	3 Leads	<b>TQA-23820</b>	S2424549	<b>\$280</b>
GE Logiq P6 and P6 Pro ultrasound systems	<p>To Monitor:</p>  <p>To 3 Leads Set:</p> 	3 Leads	<b>TQB-23810</b>	5341189	<b>\$320</b>

### Goldway (See Mindray)

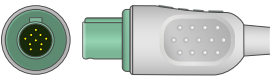
### Hellige One Piece ECG Cables

Models	Connector	Options	Part Number	OEM #	Price
Servomed 4, Generation, SCP 851, SCP 852, SCP 844, SCS 804, CardioServ, VICOM-sm		3 Leads Snap	<b>C2355S0</b>	303-442-99	<b>\$122</b>
		3 Leads Clip	<b>C2355P0</b>		<b>\$129</b>
		5 Leads Snap	<b>C2555S0</b>		<b>\$129</b>
		5 Leads Clip	<b>C2555P0</b>		<b>\$133</b>

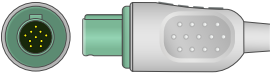

### Hellige ECG Trunk Cables

Models	Connector	Options	Part Number	OEM #	Price
Hellige, Servomed 4, Generation, SCP 851, SCP 852, SCP 844, SCS 804, CardioServ, VICOM-sm. For use with Datex Ohmeda leadwires series LX3-9050.	<p>To Monitor:</p>  <p>To 3 Leads Set:</p>  <p>To 5 Leads Set:</p> 	3 Leads	<b>TX-23550</b>		<b>\$99</b>
		5 Leads	<b>TX-25550</b>		<b>\$99</b>

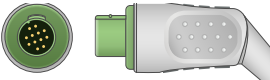
### Infinium One Piece ECG Cables

Models	Connector	Options	Part Number	OEM #	Price
Infinium Mira, Vega; Kontron: 7000, 7135, 7135B, 7141, 7210, 7250, 7251, K2000, KAAT, Kolormon, Micromon, Minimon, Supermon, Vitalmon; Larsen & Toubro (L&T Medical) Stellar P, Star 50, Galaxy, Planet, Planet 50, Cosmic		3 Leads Snap	<b>C2398S0</b>		<b>\$87</b>
		3 Leads Clip	<b>C2398P0</b>		<b>\$91</b>

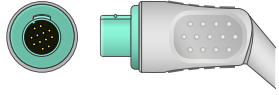
## Infinium ECG Trunk Cables

Models	Connector	Options	Part Number	OEM #	Price
Mira, Vega; Kontron: 7000, 7135, 7135B, 7141, 7210, 7250, 7251, K2000, KAAAT, Kolomon, Micromon, Minimon, Supermon, Vitalmon; Larsen & Toubro (L&T Medical) Stellar P, Star 50, Galaxy, Planet, Planet 50, Cosmic. For use with the DIN-Style Safety Leadwires.	To Monitor:  To 3 Leads Set: 	3 Leads	<b>T-13980</b>		<b>\$76</b>



## Invivo (See AAMI)

## Kontron (See Infinium)

## LL Style ECG Leads

Models	Connector	Options	Part Number	OEM #	Price
LL-style connector leads		3 Leads Snap	<b>LLL3-90S0</b>		<b>\$34</b>
		3 Leads Clip	<b>LLL3-90P0</b>		<b>\$36</b>
		5 Leads Snap	<b>LLL5-90S0</b>		<b>\$42</b>
		5 Leads Clip	<b>LLL5-90P0</b>		<b>\$45</b>

## LL Style ECG Trunk Cables

Models	Connector	Options	Part Number	OEM #	Price
	To Monitor:  To 3 Leads Set: 	3 Leads	<b>TL-13400</b>		<b>\$63</b>
		5 Leads	<b>TL-15400</b>		<b>\$66</b>

## Lohmeier One Piece ECG Cables

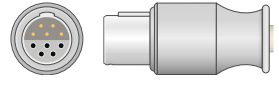
Models	Connector	Options	Part Number	OEM #	Price
M010, M011, M211 and 501 Defibrillator		3 Leads Snap	<b>C2358S0</b>		<b>\$114</b>
		3 Leads Clip	<b>C2358P0</b>		<b>\$114</b>



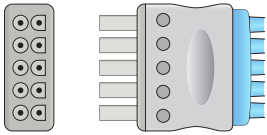
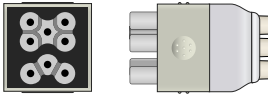
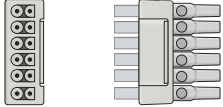

## Marquette (GE) One Piece ECG Cables

Models	Connector	Options	Part Number	OEM #	Price
Dash 1000, Dash PRO 2000, Dash 2500, Dash PRO 3000, Dash PRO 4000, Dash 5000, Eagle Systems, MAC-Lab, Solar 3000, Solar 8000, Solar 9500, Aestiva/5, Tram 100, Tram 200, Tram 300, Tram 400, Tram 500, Tram 600, Tram 800, Responder 2000, Responder 3000, Corometrics 120, GE Vivid 7 Ultrasound, Datex Ohmeda E Prestin modules and Unity Systems		3 Leads Snap	<b>C2386S0</b>	2021141-001	<b>\$99</b>
		3 Leads Clip	<b>C2386P0</b>	2021141-001	<b>\$103</b>
		5 Leads Snap	<b>C2586S0</b>		<b>\$103</b>
		5 Leads Clip	<b>C2586P0</b>		<b>\$106</b>

**Marquette (GE) ECG Leads**

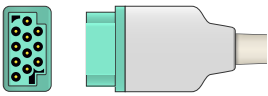
Models	Connector	Options	Part Number	OEM #	Price
		3 Leads Snap	<b>LQ3-90S0</b>	416467-004, 411202-001, 411203-001	<b>\$59</b>
		3 Leads Clip	<b>LQ3-90P0</b>	412682-001, 412682-002	<b>\$62</b>
		5 Leads Snap	<b>LQ5-90S0</b>	411202-001, 411200-001	<b>\$59</b>
		5 Leads Clip	<b>LQ5-90P0</b>	414556-001, 414556-002, 412681-001, 412681-002, 412681-005, 414556-001, 414556-002, 414556-003, E9002ZW	<b>\$62</b>
		5 Leads V2-V6 Snap	<b>LV5-90S0</b>	416468-001, 416468-003	<b>\$62</b>
		5 Leads V2-V6 Clip	<b>LV5-90P0</b>	416467-001, 416467-003	<b>\$62</b>
GE ApexPro FH Telemetry System		3 Leads Snap	<b>LAP3-90S0</b>		<b>\$59</b>
		3 Leads Clip	<b>LAP3-90P0</b>		<b>\$59</b>
		5 Leads Snap	<b>LAP5-90S0</b>	394111-012, 394111-006	<b>\$62</b>
		5 Leads Clip	<b>LAP5-90P0</b>	394111-005, 394111-011	<b>\$62</b>
		6 Leads Snap	<b>LAP6-90S0</b>		<b>\$62</b>
		6 Leads Clip	<b>LAP6-90P0</b>		<b>\$62</b>
GE ApexPro CH Telemetry System		6 Leads Snap	<b>LQB6-90S0</b>	421930-001, 421930-002, 421930-003	<b>\$62</b>
		6 Leads Clip	<b>LQB6-90P0</b>	421932-001, 421932-002, 421932-003	<b>\$62</b>

**Marquette (GE) ECG Trunk Cables**

Models	Connector	Options	Part Number	OEM #	Price
Dash 1000, Dash Pro 2000, Dash 2500, Dash Pro 3000, Dash Pro 4000, Dash 5000, Eagle Systems, MAC-Lab, Solar 3000, Solar 8000, Solar 9500, Aestiva/5, Tram 100, Tram 200, Tram 300, Tram 400, Tram 500, Tram 600, Tram 800, Unity Systems and Carescape	To Monitor:  To 3 / 5 Leads Set: 	5 Leads	<b>TQ-25860</b>	2017003-001, 2017003-002, 2017003-003, 2017004-001, 412681-005, 412931-001, E9002ZB	<b>\$83</b>
For use with safety DIN leadwires	To Monitor:  To 3 Leads DIN Set:  To 5 Leads DIN Set: 	3 Leads	<b>T-13860</b>	CB-713006R	<b>\$60</b>
		5 Leads	<b>T-15860</b>	CB-715006	<b>\$60</b>

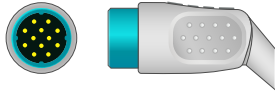

## Medtronic One Piece ECG Cables

Models	Connector	Options	Part Number	OEM #	Price
Lifepak 11, Lifepak 12, Lifepak 15, Lifepak 20, Lifepak 20E		3 Leads Snap	<b>C2327S0</b>	11110-000029, 3006218-02	<b>\$137</b>
		3 Leads Clip	<b>C2327P0</b>		<b>\$144</b>
		5 Leads Snap	<b>C2527S0</b>	11110-000066	<b>\$148</b>
		5 Leads Clip	<b>C2527P0</b>		<b>\$152</b>

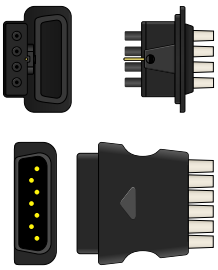

## Medtronic ECG Leads

Models	Connector	Options	Part Number	OEM #	Price
Lifepak 11, Lifepak 12, Lifepak 15 and Lifepak 20, Lifepak 20E		4 Leads Snap	<b>LDA4-120S0</b>	11110-000102, 805265-03	<b>\$87</b>
		4 Leads Clip	<b>LDA4-120P0</b>		<b>\$87</b>
		6 Leads Snap	<b>LDB6-90S0</b>	11110-000103, 805265-04	<b>\$89</b>
		6 Leads Clip	<b>LDB6-90P0</b>		<b>\$89</b>

## Medtronic ECG Trunk Cables

Models	Connector	Options	Part Number	OEM #	Price
Lifepak 11, Lifepak 12, Lifepak 15, Lifepak 20, Lifepak 20E	<p>To Monitor:</p>  <p>To 4 / 6 Leads Set:</p> 	10 Leads	<b>TD-210270</b>	11110-000110, 11110-000111, 805265-23	<b>\$99</b>

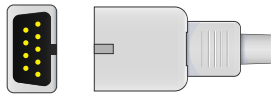
## MEK One Piece ECG Cables

Models	Connector	Options	Part Number	OEM #	Price
MP1000, MP600, MP500		3 Leads Snap	<b>C2310S0</b>		<b>\$76</b>
		3 Leads Clip	<b>C2310P0</b>		<b>\$76</b>
		5 Leads Snap	<b>C2510S0</b>		<b>\$95</b>
		5 Leads Clip	<b>C2510P0</b>		<b>\$95</b>
M160246 and 360697; Votem VP-700, VP-1000; VP-1200		3 Leads Snap	<b>C2311S0</b>		<b>\$87</b>
		3 Leads Clip	<b>C2311P0</b>		<b>\$91</b>
		5 Leads Snap	<b>C2511S0</b>		<b>\$95</b>
		5 Leads Clip	<b>C2511P0</b>		<b>\$99</b>



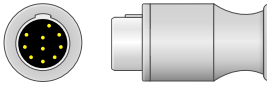
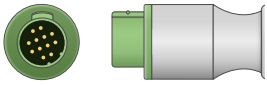

### Mennen One Piece ECG Cables

Models	Connector	Options	Part Number	OEM #	Price
900, 1100, 1110, Horizon 2000, 2100, 2200, 5200, Horizon 9000XL, MR1200, 1270, 1280, 1300, 1380		3 Leads Snap	<b>C2374S0</b>		<b>\$137</b>
		3 Leads Clip	<b>C2374P0</b>		<b>\$144</b>
		5 Leads Snap	<b>C2574S0</b>		<b>\$148</b>
		5 Leads Clip	<b>C2574P0</b>		<b>\$152</b>
Envoy, Enmove 1000		3 Leads Snap	<b>C2375S0</b>		<b>\$114</b>
		3 Leads Clip	<b>C2375P0</b>		<b>\$114</b>
		5 Leads Snap	<b>C2575S0</b>		<b>\$133</b>
		5 Leads Clip	<b>C2575P0</b>		<b>\$133</b>

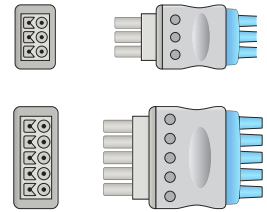
### Mennen ECG Leads

Models	Connector	Options	Part Number	OEM #	Price
Mennen Envoy and Schiller Argus LCM		3 Leads Snap	<b>LMN3-90S0</b>		<b>\$50</b>
		3 Leads Clip	<b>LMN3-90P0</b>		<b>\$50</b>
		5 Leads Snap	<b>LMN5-90S0</b>		<b>\$70</b>
		5 Leads Clip	<b>LMN5-90P0</b>		<b>\$70</b>

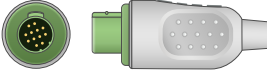
### Mennen ECG Trunk Cables

Models	Connector	Options	Part Number	OEM #	Price	
Envoy, Enmove 1000	To Monitor:   To 3 Leads Set:   To 5 Leads Set: 	3 Leads	<b>TA-23750</b>		<b>\$116</b>	
		5 Leads	<b>TA-25750</b>		<b>\$116</b>	

### Mindray One Piece ECG Cables (Also see Datascope)

Models	Connector	Options	Part Number	OEM #	Price
Mindray: PM9000, PM8000, PM7000 with a 6-pin connector; Goldway: UT4000A, UT4000A, UT4000Apro, UT6000A, UT4000B, UT4000C, UT4000F, UT6000F, UT4000Fpro, UT4800, Goldway G40		3 Leads Snap	<b>C2340S0</b>		<b>\$76</b>
		3 Leads Clip	<b>C2340P0</b>		<b>\$76</b>
		5 Leads Snap	<b>C2540S0</b>		<b>\$95</b>
		5 Leads Clip	<b>C2540P0</b>		<b>\$95</b>

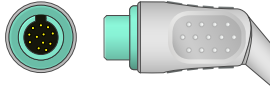

**Mindray One Piece ECG Cables (Continued)**

Models	Connector	Options	Part Number	OEM #	Price
MEC 1000, PM5000, PM6000 with a 12-pin connector, BeneView T5, T8, DPM6, DPM7 and iPM-9800. Also compatible for Penlon Intermed patient monitors		3 Leads Snap	<b>C2312S0</b>	0010-30-42719	<b>\$99</b>
		3 Leads Clip	<b>C2312P0</b>		<b>\$106</b>
		5 Leads Snap	<b>C2512S0</b>		<b>\$110</b>
		5 Leads Clip	<b>C2512P0</b>		<b>\$114</b>

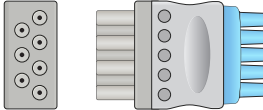
**Mindray ECG Leads (Also see Datascope)**

Models	Connector	Options	Part Number	OEM #	Price
Mindray TMS-6016 and Tel-100 Telemetry System. Also for use with Mortara and Mennen Telemetry Systems		3 Leads Snap	<b>LTM3-90S0</b>	115-004867-00	<b>\$84</b>
		3 Leads Clip	<b>LTM3-90P0</b>	115-004871-00	<b>\$84</b>
		5 Leads Snap	<b>LTM5-90S0</b>	115-004869-00	<b>\$96</b>
		5 Leads Clip	<b>LTM5-90P0</b>	115-004873-00	<b>\$96</b>

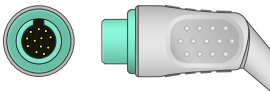
**Mindray ECG Trunk Cables (Also see Datascope)**

Models	Connector	Options	Part Number	OEM #	Price
PM5000, PM6000, T5 and T8	To Monitor:  To 3 / 5 Leads Set: 	3 / 5 Leads	<b>TR-25120</b>	0010-30-42719	<b>\$92</b>

**NEC ECG Leads**

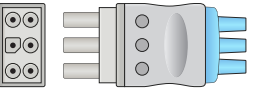
Models	Connector	Options	Part Number	OEM #	Price
All NEC systems		3 Leads Snap	<b>LECA3-90S0</b>		<b>\$31</b>
		3 Leads Clip	<b>LECA3-90P0</b>		<b>\$34</b>

**Nihon Kohden One Piece ECG Cables (Also see AAMI)**

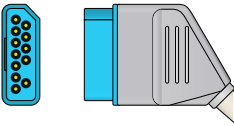
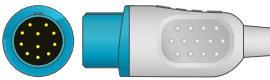
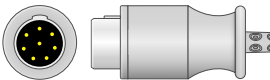
Models	Connector	Options	Part Number	OEM #	Price
BSM-2300 Life Scope I, BSM-2301A, BSM-2301K, BSM-2351A, BSM-4100, BSM-4102, BSM-4102A, Life Scope P, BSM-5100 Life Scope A, Life Scope TR, BSM-6000 series, BSM-6301K, BSM-6501K, BSM-6701K, Life Scope J, BSM-9101, PVM-2701, BSM-9510 Life Scope M, BSM-9500 Life Scope S		3 Leads Snap	<b>C2309S0</b>		<b>\$99</b>
		3 Leads Clip	<b>C2309P0</b>		<b>\$99</b>
OEC-6102A (s/n<20156), OEC-6105A (s/n<20226), OEC-6120A/J/K, TEC-7621C, TEC-7631C, TEC-7721C, TEC-7731C, TEC-7731K, TEC-7700, Cardiolife Bifasic Defibrillator		3 Leads Snap	<b>C2313S0</b>	BC-753V	<b>\$99</b>
		3 Leads Clip	<b>C2313P0</b>		<b>\$99</b>
Merlin 78352C, Merlin 78354C, Merlin 78834C, M1001A, M1002A, Viridia, Omnicare CMA, ML65A, 66A, Heartstream and Codemaster XL		3 Leads Snap	<b>C23029S0</b>		<b>\$99</b>
		3 Leads Clip	<b>C23029P0</b>		<b>\$106</b>
		5 Leads Snap	<b>C25029S0</b>		<b>\$110</b>
		5 Leads Clip	<b>C25029P0</b>		<b>\$114</b>



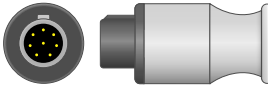
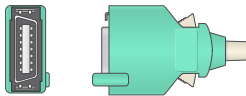

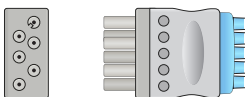
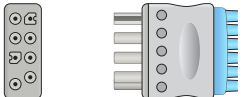

**Nihon Kohden One Piece ECG Cables (Continued)**

Models	Connector	Options	Part Number	OEM #	Price
OEC-6102A (s/n<20156), OEC-6105A (s/n<20226), OEC-6120A/J/K		3 Leads Snap	<b>C2308S0</b>		<b>\$99</b>
		3 Leads Clip	<b>C2308P0</b>		<b>\$106</b>
		5 Leads Snap	<b>C2508S0</b>		<b>\$110</b>
		5 Leads Clip	<b>C2508P0</b>		<b>\$114</b>
Life Scope OPV-1500, Life Scope N OPV-1500K		3 Leads Snap	<b>C2316S0</b>		<b>\$99</b>
		3 Leads Clip	<b>C2316P0</b>		<b>\$99</b>

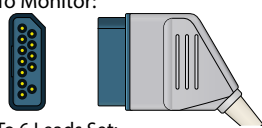
**Nihon Kohden ECG Leads (Also see AAMI and Spacelabs)**

Models	Connector	Options	Part Number	OEM #	Price
Cardiolife, Life Scope series 6, 8, 9, 11, 6102, 6205, 6120		3 Leads Snap	<b>LKA3-90S0</b>		<b>\$64</b>
		3 Leads Clip	<b>LKA3-90P0</b>		<b>\$67</b>
		5 Leads Snap	<b>LKA5-90S0</b>		<b>\$67</b>
		5 Leads Clip	<b>LKA5-90P0</b>		<b>\$70</b>
BSM-2300 Life Scope I, BSM-2301, BSM-4100 Life Scope P, BSM-5100 Life Scope A, Life Scope TR, BSM-6000 series, BSM-6301K, BSM-6501K, BSM-6701K, BSM-9510 Life Scope M, BSM-9800 Life Scope S, ZM-900 Series Transmitters, Life Scope 6700 Series		3 Leads Snap	<b>LKB3-90S0</b>	BR-913P K910A, BR-913PA K910B	<b>\$84</b>
		3 Leads Clip	<b>LKB3-90P0</b>	BR-903P K911, BR-903PA K911A	<b>\$84</b>
		6 Leads Snap	<b>LKB6-90S0</b>	BR-916P K915, BR-916PA K915A	<b>\$89</b>
		6 Leads Clip	<b>LKB6-90P0</b>	BR-906P K912, BR-916PA K915A	<b>\$89</b>

**Nihon Kohden ECG Trunk Cables (Also see AAMI and Spacelabs)**

Models	Connector	Options	Part Number	OEM #	Price
BSM-2300 Life Scope I, BSM-2301, BSM-2351A, BSM-4100 Life Scope P, BSM-4102, BSM-4102A, BSM-5100 Life Scope A, Life Scope TR, BSM-6000 series, BSM-6301K, BSM-6501K, BSM-6701K, Life Scope J, BSM-9101, PVM-2701, BSM-9510 Life Scope M, BSM-9800 Life Scope S, Life Scope 6700 Series	To Monitor:  To 6 Leads Set: 	6 Leads	<b>TK-25090</b>	JC-906P	<b>\$99</b>
OEC-6102A (s/n<20156), OEC-6105A (s/n<20226), OEC-6120A/J/K, TEC-7100K	To Monitor:  To 3 / 5 Leads Set: 	3 / 5 Leads	<b>TK-25080</b>		<b>\$99</b>
BSM-7102A, OMP-7201C, OMP-7203C, TEC-5200A (s/n<20421)	To Monitor:  To 3 / 5 Leads Set: 	3 / 5 Leads	<b>TK-25070</b>		<b>\$99</b>

**Palco** (See AAMI)

**Penlon** (See Mindray)

## Petas One Piece ECG Cables

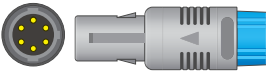
Models	Connector	Options	Part Number	OEM #	Price
KMA160R, 165R, 260R, K-250, 300		4 Leads Snap	<b>C24026S0</b>		<b>\$76</b>
		4 Leads Clip	<b>C24026P0</b>		<b>\$99</b>

## Philips One Piece ECG Cables (Also see AAMI)

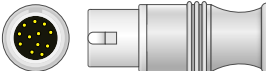
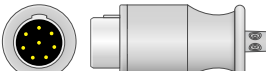
Models	Connector	Options	Part Number	OEM #	Price
Philips HeartStart defibrillator, Philips Agilent, Envisor, IntelliVue, MP 20, MP 30, MP 50, IE33, Philips HeartStart defibrillator, Philips Agilent, IntelliVue, IE33, 43100A, 43110A, 43120A, 78352C, 78354C, 78834C, 862474 C3, M1001A, M1002A, M1165A, M1166A, M1167A, M1175A, M1177A, M1204A, M1205A, M1264A, M1275A Transport, M1280A, M1722A/B, M1723A/B, M2475B, M2601A, M3000A, M3001A, M3046A, M2, M3, M4, M4735A, V24E, Agilent 50XM Fetal Monitor; Newtech NT3A; Solaris NT3A, NT3B, NT3C, NT3E, NT3F		3 Leads Snap	<b>C2385S0</b>	M1972A, 2017003-001	<b>\$99</b>
		3 Leads Clip	<b>C2385P0</b>	M1981A	<b>\$106</b>
		5 Leads Snap	<b>C2585S0</b>	M1977A	<b>\$110</b>
		5 Leads Clip	<b>C2585P0</b>	M1986A	<b>\$114</b>
Codemaster XL, Codemaster 100, 43100A, 43110A, 43110M, 43120A, MC Defibrillator, 43200A Portable, M3500B, 77000AC, 77020A, 77010AC, Sonos/AC/AR, 77025A, 77030A, 77035A, 77040A, 78208A, 78210A, 78330A, 7833 1A, 78332A, 78333A, 78341A, 78342A, 78345A, 78346A, 78351T, 78352A/C, 78353A/B, 78354A, 78532A/B, 78534A/B/C, 78619A, 78620A, 78660A/B, 78661A/B, 78670A, 78671A, M1722A/B, M1723A/B, M2400A, M2406A, Sonos 2000/2500, tems, M2425A, M2475B		3 Leads Snap	<b>C23029S0</b>	M1735A	<b>\$99</b>
		3 Leads Clip	<b>C23029P0</b>		<b>\$106</b>
		5 Leads Snap	<b>C25029S0</b>	M1736A	<b>\$110</b>
		5 Leads Clip	<b>C25029P0</b>		<b>\$114</b>



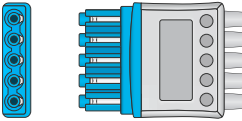
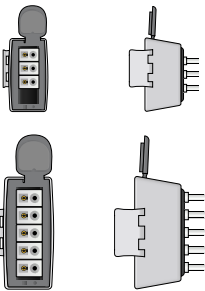



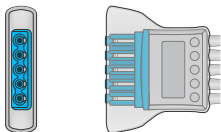
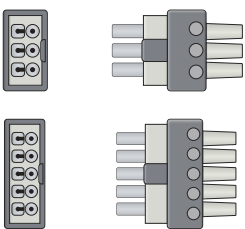

## Philips ECG Leads (Also see AAMI)

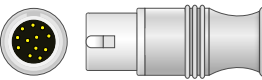
Models	Connector	Options	Part Number	OEM #	Price
For use with Philips M1668A ECG trunk cable		3 Leads Snap	<b>LP3-90S0</b>	M1673A	<b>\$55</b>
		3 Leads Clip	<b>LP3-90P0</b>	M1671A, M1675A	<b>\$55</b>
		5 Leads Snap Limbs	<b>LPA5-90S0</b>	M1644A, 989803144991	<b>\$60</b>
		5 Leads Clip Limbs	<b>LPA5-90P0</b>	M1968A, 989803125841	<b>\$60</b>
		5 Leads Snap Chest V2-V6	<b>LPB5-90S0</b>	M1602A	<b>\$62</b>
		5 Leads Clip Chest V2-V6	<b>LPB5-90P0</b>	M1976A	<b>\$62</b>
M2601A, M2600A and M2636A Viridia M2600A Telemetry System		3 Leads Snap	<b>LAT3-90S0</b>	M2590A, 989803106311	<b>\$65</b>
		3 Leads Clip	<b>LAT3-90P0</b>	M2591A	<b>\$65</b>
		5 Leads Snap	<b>LAT5-90S0</b>	M2592A, 989803106331	<b>\$69</b>
		5 Leads Clip	<b>LAT5-90P0</b>	M2593A, 989803106341	<b>\$69</b>

### Philips ECG Leads (Continued)

Models	Connector	Options	Part Number	OEM #	Price
IntelliVue 862108, M4840A, M2600B, M2601B Viridia Telemetry		5 Leads Snap	<b>LHT5-90SO</b>	989803152071, 989803133871, 989803137241	<b>\$65</b>
		5 Leads Clip	<b>LHT5-90PO</b>	989803152051, 989803133881, 989803137251	<b>\$65</b>
For use with Philips M1500A trunk cable		3 Leads Snap	<b>LAB3-90SO</b>	M1605A, M1633A, M1626A, M2592A, M1613A, 0012-00-0847	<b>\$55</b>
		3 Leads Clip	<b>LAB3-90PO</b>	M1603A, M1608A, 989803104371, 989803104401, M1609A, 989803104411	<b>\$55</b>
		5 Leads Snap	<b>LAB5-90SO</b>	M1625A, 0012-00-1003-01	<b>\$60</b>
		5 Leads Clip	<b>LAB5-90PO</b>	M1623A, M1621A, M1629A, 989803104541	<b>\$60</b>

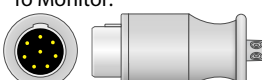
### Philips ECG Trunk Cables

Models	Connector	Options	Part Number	OEM #	Price
78352C, 78354C, 78834C, Legacy HP Patient Monitors 862472 to 862475, C3 Monitor 862478, 862479 C3 Monitor 863064, 863065, 863066, 863068, SureSigns VM6, VM8, ECG Modules M1001A/B, M1002A/B, Multi-Measurement Modules M3000A, M3001A, M3002A MMS X2, M8102A MP2 Monitor, M8105A MP5 Monitor, M4735A, HeartStart XL, Defibrillator Monitor M3535A, M3536A, HeartStart MRx Defibrillator. For use with the Philips M1644A (LPA5-90S0) Lead Set	<p>To Monitor:</p>  <p>To 3 Leads Set:</p>  <p>To 5 Leads Set:</p> 	3 Leads	<b>TP-23850</b>	M1669A, 989803145071	<b>\$72</b>
		5 Leads	<b>TP-25850</b>	M1668A, 989803145061	<b>\$75</b>
Merlin, Viridia, Omnicare CMA, Heartstream, Envisor, IntelliVue, V24/V26, IE33, C Series Monitors, 78352C, 78354A/C, 78834A/B/C, M1001A, M1001B, M1002A, M1002B, M1722A, M1722B, M1723A, M1723B, M2475B, M3000A, M3001A, M4735A. For use with the Philips M1605A (LAB3-90S0) Lead Set	<p>To Monitor:</p>  <p>To 3 Leads Set:</p>  <p>To 5 Leads Set:</p> 	3 Leads	<b>TA-23850</b>	M1500A, M1510A, M1540C, 0012-00-0846, 4535-612-33921	<b>\$72</b>
		5 Leads	<b>TA-25850</b>	M1520A, M1560C, 0012-00-1002-01	<b>\$75</b>
Codemaster XL, 782xxA Series, 783xxA Series, 785xxA/B/C Series, 786xxA/B Series, 77000AC, 77020A/AC, 77020AR, 77025A, 77030A, 77035A, 77040A, 78208A, 78210A, 78330A, 78331A, 78332A, 78333A, 78341A, 78342A, 78345A, 78346A, 78351T, 78352A, 78353A/B, 78354A, 78532A/B, 78534A/B/C, M1722A/B, M1723A/B, M2400A, M2406A, M2475B, M3500B and 43011A Defibrillator. For use with the Philips M1605A (LAB3-90S0) Lead Set	<p>To Monitor:</p>  <p>To 3 Leads Set:</p>  <p>To 5 Leads Set:</p> 	3 Leads	<b>TA-230290</b>	M1580A	<b>\$72</b>
		5 Leads	<b>TA-250290</b>	M1600A	<b>\$75</b>

**Physio Control** (See AAMI and Medtronic)

**Primedic One Piece ECG Cables**

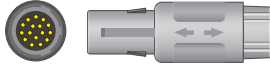
Models	Connector	Options	Part Number	OEM #	Price
Primedic Defi-Monitor DM 10, DM 30		4 Leads IEC Clip	<b>C2415P-I0</b>		<b>\$122</b>

**Schiller One Piece ECG Cables**

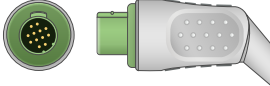
Models	Connector	Options	Part Number	OEM #	Price
Defigard 4000 defibrillator		3 Leads Snap	<b>C2354S0</b>		<b>\$95</b>
		3 Leads Clip	<b>C2354P0</b>		<b>\$95</b>

**Siemens One Piece ECG Cables** (Also see AAMI and Drager)

Models	Connector	Options	Part Number	OEM #	Price
Sirecust Series 400, 500, 600, 700, 900, 1200, Sirecust 341, 610, 620, 630, 720, 722, 730, 732, 900, 960, 961, 1260, 1281, 1801, 400, 500 ECG Monitor, Modulo Polymed y Modulbox Sirem		3 Leads Snap	<b>C2376S0</b>		<b>\$76</b>
		3 Leads Clip	<b>C2376P0</b>		<b>\$76</b>
		5 Leads Snap	<b>C2576S0</b>		<b>\$95</b>
		5 Leads Clip	<b>C2576P0</b>		<b>\$95</b>

**Siemens ECG Trunk Cables** (Also see AAMI and Drager)

Models	Connector	Options	Part Number	OEM #	Price
Sirecust Series 400, 500, 600, 700, 900, 1200, Sirecust 341/610/620/ 630/720/722, Sirecust 730/732/900/960/961/ 1260, Sirecust 1281/ 1801/400/500, ECG Monitor, Modulo Polymed, Modulbox Sirem		3 Leads	<b>TM-23760</b>		<b>\$59</b>
		5 Leads	<b>TM-25760</b>		<b>\$63</b>

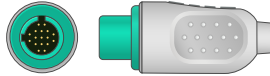

**Spacelabs One Piece ECG Cables** (Also see AAMI)

Models	Connector	Options	Part Number	OEM #	Price
True-Link Cable for 90309, 90496 Ultraview, 90369 Ultraview, 90367 Ultraview, 91220 mCare 300, 91369 Ultraview SL and Elance Series		3 Leads Snap	<b>C2396S0</b>	700-0008-08, 72713	<b>\$99</b>
		3 Leads Clip	<b>C2396P0</b>		<b>\$106</b>
		5 Leads Snap	<b>C2596S0</b>	700-0008-06, 72715	<b>\$110</b>
		5 Leads Clip	<b>C2596P0</b>		<b>\$114</b>







**Spacelabs ECG Leads** (Also see AAMI and DIN Leads)

Models	Connector	Options	Part Number	OEM #	Price
90492, 91220, 90496, 91496		3 Leads Snap	<b>LLB3-90S0</b>	012-0498, 700-0007-00, 700-0007-02	<b>\$42</b>
		3 Leads Clip	<b>LLB3-90P0</b>	700-0006-00, 700-0006-02	<b>\$45</b>
		5 Leads Snap	<b>LLB5-90S0</b>	700-0007-08, 700-0007-10	<b>\$56</b>
		5 Leads Clip	<b>LLB5-90P0</b>	700-0006-08, 700-0006-10	<b>\$59</b>

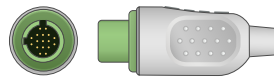

**Spacelabs ECG Leads** (Continued) (Also see AAMI and DIN Leads)

Models	Connector	Options	Part Number	OEM #	Price
	 	3 Leads Snap	<b>LSL3-9050</b>		<b>\$42</b>
		3 Leads Clip	<b>LSL3-90P0</b>		<b>\$45</b>
		5 Leads Snap	<b>LSL5-9050</b>		<b>\$56</b>
		5 Leads Clip	<b>LSL5-90P0</b>		<b>\$59</b>

**Spacelabs ECG Trunk Cables** (Also see AAMI)

Models	Connector	Options	Part Number	OEM #	Price
90492, 90496 Ultraview, 90369 Ultraview, 90367 Ultraview, 91496, Elance Series	To Monitor:  To 3 Leads Set:  To 5 Leads Set: 	3 Leads	<b>TL-23960</b>	012-0108-01, 7271	<b>\$72</b>
		5 Leads	<b>TL-25960</b>	700-0008-06, 7271	<b>\$75</b>
For use with safety DIN leadwires	To Monitor:  To 3 Leads DIN Set:  To 5 Leads DIN Set: 	3 Leads	<b>T-13960</b>	700-0008-10, 700-0008-11	<b>\$52</b>
		5 Leads	<b>T-15960</b>		<b>\$54</b>

**S&W Artema One Piece ECG Cables**

Models	Connector	Options	Part Number	OEM #	Price
S&W Artema: 8000, Diascope 1, Diascope 2, Diascope NT, Athena, Cardio Aid 200; Air Shields monitors	 	3 Leads Snap	<b>C239750</b>		<b>\$152</b>
		3 Leads Clip	<b>C2397P0</b>		<b>\$152</b>

**Welch Allyn One Piece ECG Cables**

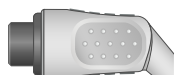
Models	Connector	Options	Part Number	OEM #	Price
Propaq 100 Series, Propaq 200 Series, Propaq Encore, Propaq CS, Ultra Smart, Atlas, PIC 30, PIC 40 and PIC 50	 	3 Leads Snap	<b>C234050</b>		<b>\$76</b>
		3 Leads Clip	<b>C2340P0</b>		<b>\$76</b>
		5 Leads Snap	<b>C254050</b>		<b>\$95</b>
		5 Leads Clip	<b>C2540P0</b>		<b>\$95</b>

**Zoll** (See AAMI)





# Disposable ECG

Single-use leadwires and one-piece cables reduce cross-contamination from healthcare-associated infections

Disposable Leadwires  
36 inch leadwires



One Piece Disposable  
11 foot cable



Leadwire Adapters  
Connect to any trunk cable







## Datascope Disposable One Piece ECG Cable

Models	Connector	Options	Part Number	OEM #	Packaging	Price
KMA160R, 165R, 260R, K-250, 300		5 Leads Grabber	<b>C2540DP0</b>		Case of 10	<b>\$189</b>

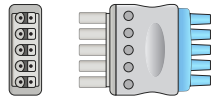
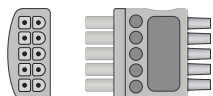
## Datascope Disposable ECG Leadwires

Models	Connector	Options	Part Number	OEM #	Packaging	Price
Datascope, Mindray bedside monitors		3 Leads Grabber	<b>LR3-90DP0</b>		Case of 10	<b>\$139</b>
		5 Leads Grabber	<b>LR5-90DP0</b>		Case of 10	<b>\$129</b>
Datascope Mobility leadwires		3 Leads Grabber	<b>LDT3-90DP0</b>		Case of 10	<b>\$129</b>
		5 Leads Grabber	<b>LDT5-90DP0</b>		Case of 10	<b>\$139</b>

## DIN-Style Safety Disposable ECG Leadwires

Models	Connector	Options	Part Number	OEM #	Packaging	Price
		3 Leads Grabber	<b>L3-90DP0</b>		Case of 10	<b>\$59</b>
		5 Leads Grabber	<b>L5-90DP0</b>		Case of 10	<b>\$69</b>

## Marquette Disposable One Piece ECG Cable

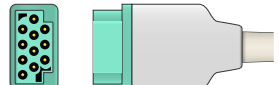
Models	Connector	Options	Part Number	OEM #	Packaging	Price
KMA160R, 165R, 260R, K-250, 300		5 Leads Grabber	<b>C2586DP0</b>		Case of 10	<b>\$189</b>

## Marquette Disposable ECG Leadwires

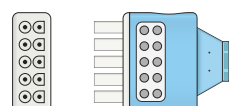
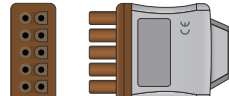
Models	Connector	Options	Part Number	OEM #	Packaging	Price
GE Multi-Link trunk cables		3 Leads Grabber	<b>LQ3-90DP0</b>		Case of 10	<b>\$129</b>
		5 Leads Grabber	<b>LQ5-90DP0</b>	Covidien: 33112	Case of 10	<b>\$139</b>
GE Multi-Link V2 - V6 leads		5 Leads Grabber	<b>LV5-90DP0</b>		Case of 10	<b>\$139</b>

## Nihon Kohden Disposable ECG Leadwires

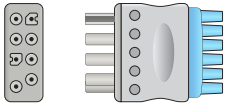
Models	Connector	Options	Part Number	OEM #	Packaging	Price
		3 Leads Grabber	<b>LKB3-90DP0</b>		Case of 10	<b>\$129</b>
		6 Leads Grabber	<b>LKB6-90DP0</b>	Covidien: 33134	Case of 10	<b>\$139</b>

## Philips Disposable One Piece ECG Cable

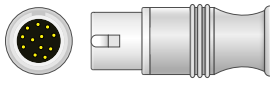
Models	Connector	Options	Part Number	OEM #	Packaging	Price
Philips IntelliVue bedside monitors		5 Leads Grabber	<b>C2585DP0</b>		Case of 10	<b>\$199</b>

## Philips Disposable ECG Leadwires

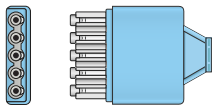
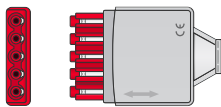
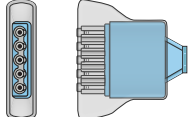
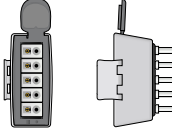
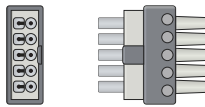
Models	Connector	Options	Part Number	OEM #	Packaging	Price
Philips IntelliVue bedside monitors		3 Leads Grabber	<b>LPA3-90DP0</b>	989803173121	Case of 10	<b>\$129</b>
		5 Leads Grabber	<b>LPA5-90DP0</b>	Philips: 989803173131; Covidien 33114	Case of 10	<b>\$139</b>
Philips IntelliVue V2 - V6 leads		5 Leads Grabber	<b>LPB5-90DP0</b>		Case of 10	<b>\$139</b>
Philips IntelliVue M2601B telemetry		3 Leads Grabber	<b>LHT3-90DP0</b>	989803173141	Case of 10	<b>\$129</b>
		5 Leads Grabber	<b>LHT5-90DP0</b>	Philips: 989803173151	Case of 10	<b>\$139</b>
Philips M2601A telemetry		3 Leads Grabber	<b>LAT3-90DP0</b>		Case of 10	<b>\$139</b>
		5 Leads Grabber	<b>LAT5-90DP0</b>	Covidien: 33113	Case of 10	<b>\$159</b>
Philips Twin Pin (AA style) for use with Philips M1500 Series bedside trunk cables		3 Leads Grabber	<b>LAB3-90DP0</b>		Case of 10	<b>\$129</b>
		5 Leads Grabber	<b>LAB5-90DP0</b>		Case of 10	<b>\$139</b>

## Spacelabs Disposable One Piece ECG Cable

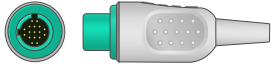
Models	Connector	Options	Part Number	OEM #	Packaging	Price
		5 Leads Grabber	<b>C2596DP0</b>		Case of 10	<b>\$199</b>

## Spacelabs Disposable ECG Leadwires

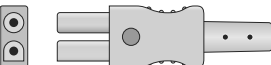
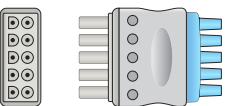
Models	Connector	Options	Part Number	OEM #	Packaging	Price
Spacelabs Tru-Link connector		3 Leads, Grabber	<b>LLB3-90DP0</b>		Case of 10	<b>\$129</b>
		5 Leads Grabber	<b>LLB5-90DP0</b>		Case of 10	<b>\$139</b>
		3 Leads Grabber	<b>LSL3-90DP0</b>		Case of 10	<b>\$129</b>
		5 Leads Grabber	<b>LSL5-90DP0</b>		Case of 10	<b>\$139</b>



ECG lead adapters are available to connect any disposable leadwire to any existing monitor trunk cable, standardizing your lead wires and improving inventory management. Call us so one of our experts can assist you in designing the best solution to support your continuum of care.

Can't find what you are looking for?  
Call one of our experts at 866-373-6767, we'll help you find it!

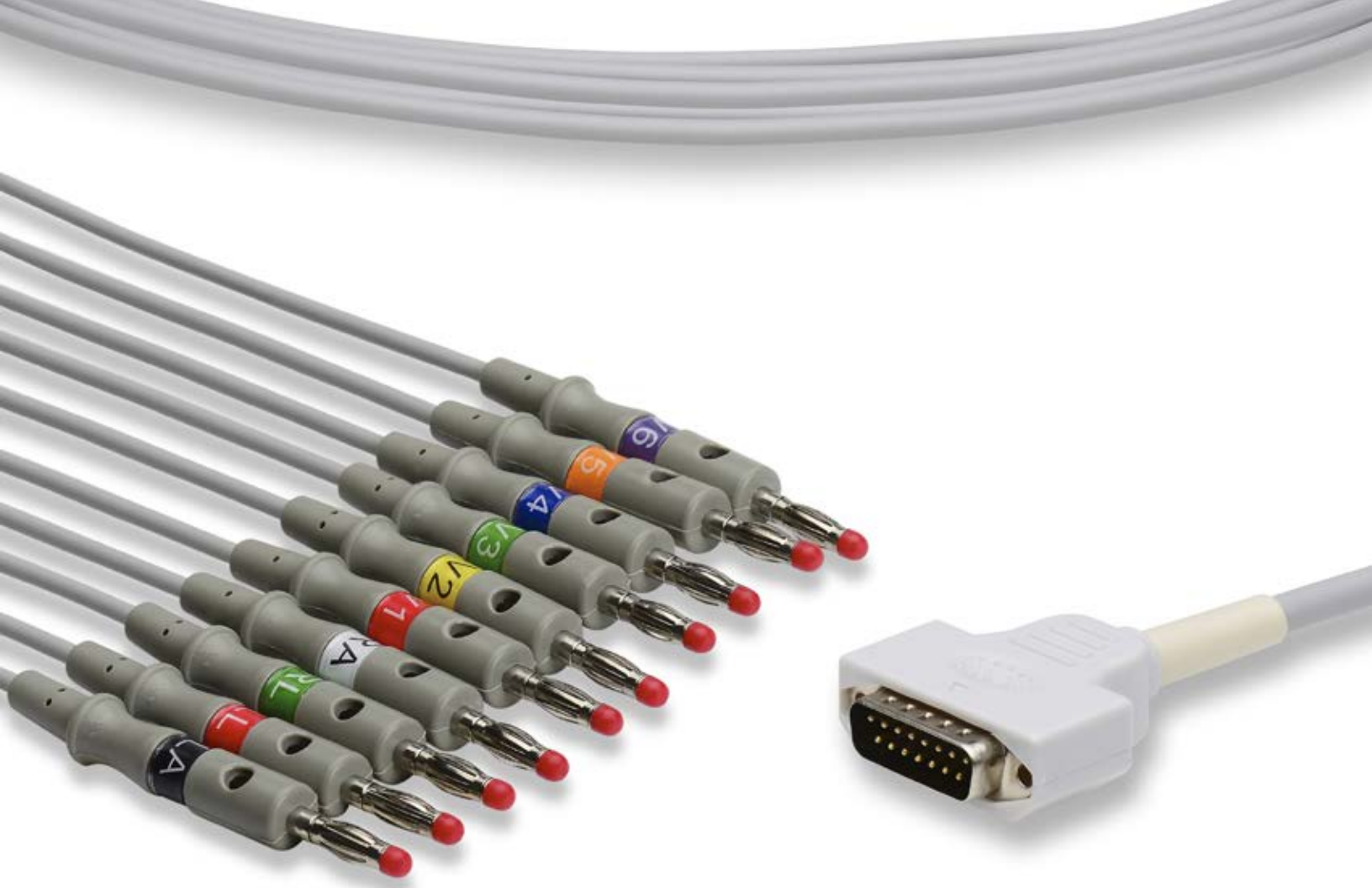

**One-Piece Cables**  
12 feet to limbs  
10.6 feet to chest

**Leadwire Sets**  
48 inches to limbs  
32 inches to chest

**Trunk Cables**  
8 foot cable

**EKG Accessories**

# EKG

Compatible patient cables with 10 leads, banana, needle, snap or clip

# Choosing your EKG patient cable

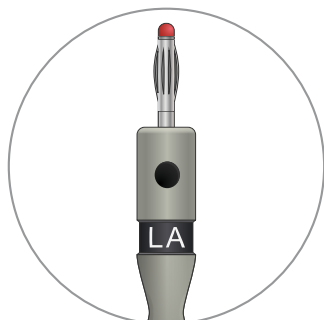

## 10 Leads Banana (4mm)

Ideal for limb clamps, suction electrodes or with adapters for tab or snap electrode pads.

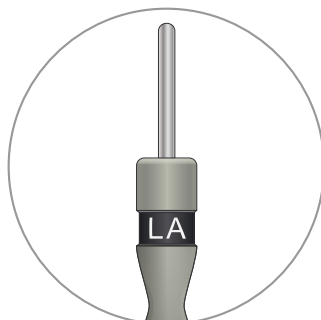

## 10 Leads Needle (3mm)

Optional terminals for use with limb claps, suction electrodes or with attachments. Smaller, 3mm connection.



## 10 Leads Snap

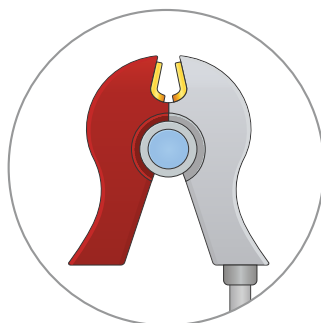

Molded snap endings are best for press stud electrode pads. Select models only.



## 10 Leads Clip (Grabber)

Molded grabber endings provide quick and easy connection to press stud electrodes. Select models only.

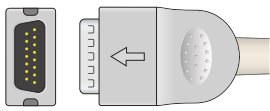
**Burdick One Piece EKG Cables**

Models	Connector	Options	Part Number	OEM #	Price
EK10, Elite, E350, E350I, E550, E560, Eclipse LE, LE I, Elite II, Quinton Eclipse Plus		10 Leads Banana	<b>K10-BK1-B0</b>	012-0700-00, 007517, 007514, 007705, 007706	<b>\$142</b>
		10 Leads Needle	<b>K10-BK1-N0</b>		<b>\$142</b>
		10 Leads Clip	<b>K10-BK1-P0</b>		<b>\$142</b>
Eclipse 4, 300, 400, 800, 850, Plus and Premier, Elite II, Eclipse LE II and Atria Systems, Atria 3000, 3100, 6100		10 Leads Banana	<b>K10-BK2-B0</b>	007704, 007725, 012-0844-00, 012-0844-01, 007785	<b>\$142</b>
		10 Leads Needle	<b>K10-BK2-N0</b>		<b>\$142</b>
		10 Leads Clip	<b>K10-BK2-P0</b>		<b>\$142</b>

**Cardioline** (See *Nihon Kohden*)**Carewell** (See *Nihon Kohden*)**Edan** (See *Spacelabs*)**Fukuda Denshi One Piece EKG Cables**

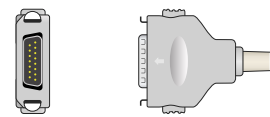
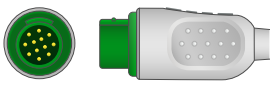
Models	Connector	Options	Part Number	OEM #	Price
FX-101, FX-102F, FX-3010, FX-328UY, FCP 2155, FCP 2201, FCP 4101, FCP 4101A, CardiMax FX-7101, FX-7102, FX-7202, FX-7402		10 Leads Banana	<b>K10-FD1-B0</b>	CP-104L	<b>\$142</b>
		10 Leads Needle	<b>K10-FD1-N0</b>		<b>\$142</b>
		10 Leads Clip	<b>K10-FD1-P0</b>		<b>\$142</b>
		12 Leads Snap	<b>KD-21099S0</b>		<b>\$142</b>
		12 Leads Clip	<b>KD-21099P0</b>		<b>\$142</b>

**Fukuda ME One Piece EKG Cables**

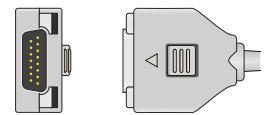
Models	Connector	Options	Part Number	OEM #	Price
KP-500, KP-500D, Cardisuny		10 Leads Banana	<b>K10-FD2-B0</b>		<b>\$142</b>
		10 Leads Needle	<b>K10-FD2-N0</b>		<b>\$142</b>
		10 Leads Clip	<b>K10-FD2-P0</b>		<b>\$142</b>

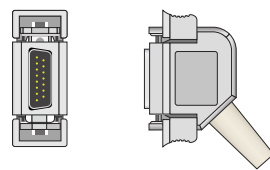

**Hellige One Piece EKG Cables**

Models	Connector	Options	Part Number	OEM #	Price
		10 Leads Banana	<b>K10-HL-B0</b>		<b>\$142</b>
		10 Leads Needle	<b>K10-HL-N0</b>		<b>\$142</b>
		10 Leads Clip	<b>K10-HL-P0</b>		<b>\$142</b>

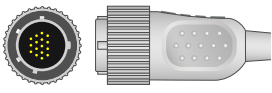
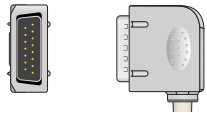
**Kenz One Piece EKG Cables**

Models	Connector	Options	Part Number	OEM #	Price
103, 106, 107, 302, 303, 1201 and Cardioline Remco Delta 1, Delta 3, Delta 30, Delta 30D, Delta 60, Delta 1 Plus, Delta 3 Plus, Delta 60 Plus, ECG 106		10 Leads Banana	<b>K10-KZ1-B0</b>	PC-104, 63050075, 63050074, 895.0586	<b>\$142</b>
		10 Leads Needle	<b>K10-KZ1-N0</b>		<b>\$142</b>
		10 Leads Clip	<b>K10-KZ1-P0</b>		<b>\$142</b>
ECG 108, 110, Cardico 302, 601, 1210, 1211		10 Leads Banana	<b>K10-KZ2-B0</b>		<b>\$142</b>
		10 Leads Needle	<b>K10-KZ2-N0</b>		<b>\$142</b>
		10 Leads Clip	<b>K10-KZ2-P0</b>		<b>\$142</b>

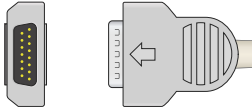
**Marquette (GE) One Piece EKG Cables**

Models	Connector	Options	Part Number	OEM #	Price
MAC 400, MAC 500, MAC 1000, MAC 1100, MAC 1200, MAC 1600, Microsmart M		10 Leads Banana	<b>K10-MQ-B0</b>		<b>\$142</b>
		10 Leads Needle	<b>K10-MQ-N0</b>		<b>\$142</b>
		10 Leads Clip	<b>K10-MQ-P0</b>		<b>\$142</b>
Eagle, Solar, Dash, MAC Lab, Cath Lab and Datex Ohmeda E Prestin module		10 Leads Snap	<b>K21086S0</b>		<b>\$142</b>
		10 Leads Clip	<b>K21086P0</b>		<b>\$142</b>

**Marquette (GE) EKG Leads**

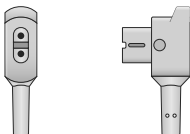
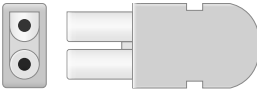
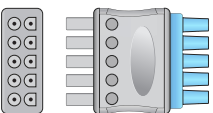
Models	Connector	Options	Part Number	OEM #	Price
AM4 Acquisition Module on monitors including MAC PC, MAC VU, MAC 6, MAC 8, MAC 12, MAC 15, CASE 12, CASE 15, CASE 16, MAX-Personal, MAX-1, CENTRA Systems with AM4 or AM5 Acquisition Modules		10 Leads Banana	<b>LQD10-LB0</b>	900177-203	<b>\$134</b>
		10 Leads Clip	<b>LQD10-LP0</b>		<b>\$134</b>
		10 Leads Snap	<b>LQD10-LS0</b>		<b>\$134</b>
		10 Leads Needle	<b>LQD10-LN0</b>		<b>\$134</b>
CAM 14 Acquisition Module or with a cable that requires CAM 14 Leadwires such as GE MAC 1100, 1200, 1200ST, MAC 1600, MAC 3500, MAC 5000, MAC 5000ST, MAC 5500, CASE Series, CASE 8000, CardioSoft, CardioSmart, CardioSys. Please note that these leadwires come with the option of no banana connectors (for use with the GE CAM 14 Electrode Connector Set 900178-001) or molded-in banana, snap, clip or needle connectors		10 Leads Without Adapters	<b>LQB10-AD0</b>	420101-002	<b>\$156</b>
		10 Leads Banana	<b>LQB10-LB0</b>		<b>\$156</b>
		10 Leads Snap	<b>LQB10-LS0</b>		<b>\$156</b>
		10 Leads Clip	<b>LQB10-LP0</b>		<b>\$156</b>
		10 Leads Needle	<b>LQB10-LN0</b>		<b>\$156</b>
MAC 400, MAC 500, MAC 1000, MAC 1100, MAC 1200		10 Leads Banana	<b>LQ10-LB0</b>	38401816, 38401817	<b>\$134</b>
		10 Leads Needle	<b>LQ10-LN0</b>		<b>\$134</b>
		10 Leads Snap	<b>LQ10-LS0</b>		<b>\$134</b>
		10 Leads Clip	<b>LQ10-LP0</b>		<b>\$134</b>

## Marquette (GE) EKG Trunk Cables

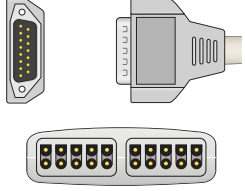
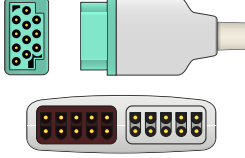
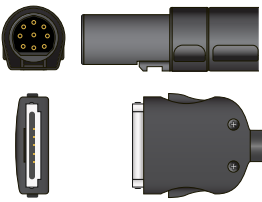
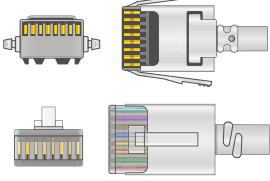
Models	Connector	Options	Part Number	OEM #	Price
MAC 400, MAC 500, MAC 1000, MAC 1100, MAC 1200		10 Leads AHA	<b>T10-MQO</b>	22341809	<b>\$119</b>
Eagle, Solar, Dash, Mac Lab, Cath Lab, and Datex Ohmeda E-Prestin and M-Prestin Modules		10 Leads AHA	<b>TQ-210860</b>	2017006-001, 416035-001, 416035-003	<b>\$119</b>
MAC 5000 / 5500 Resting ECG System and GE CASE with CAM 14 Acquisition Module. This patient cable connects to the MAC 5000 / 5500 on one side and to the CAM 14 Acquisition Module on the other		Patient Cable, 50 in. (1.3M)	<b>ECAM-GE14-S0</b>	2016560-001, 700657-001	<b>\$198</b>
		Patient Cable, 15 ft. (4.6M)	<b>ECAM-GE140</b>	2016560-002, 2016560-003, 700657-003	<b>\$198</b>
GE® AM4 and AM5 acquisition modules. For use with GE CASE 12, CASE 15, MAC PC, MAC 6, MAC 12, MAC 15, CENTRA Systems with the AM4 or AM5 acquisition module		Patient Cable, 50 in. (1.3M)	<b>EAM-GE4-S0</b>	700044-203	<b>\$140</b>
		Patient Cable, 15 ft. (4.6M)	<b>EAM-GE40</b>	700044-202, 700044-204	<b>\$140</b>

## Medtronic One Piece EKG Cables

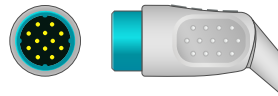
Models	Connector	Options	Part Number	OEM #	Price
Lifepak 11, Lifepak 12, Lifepak 15, Lifepak 20		10 Leads Snap	<b>K21027S0</b>		<b>\$160</b>
		10 Leads Clip	<b>K21027P0</b>		<b>\$160</b>

## Mindray (See Spacelabs)

## Mortara One Piece EKG Cables

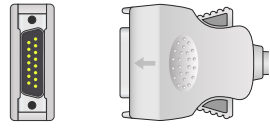
Models	Connector	Options	Part Number	OEM #	Price
ELI 10, ELI 50, ELI 100, ELI 150, ELI 150C, ELI 200, ELI 210, ELI 230, ELI 250, ELI 250C and ELI 350		10 Leads Banana	<b>K10-MT-B0</b>	9293-032-50, 9293-040-50	<b>\$142</b>
		10 Leads Needle	<b>K10-MT-N0</b>		<b>\$142</b>
		10 Leads Clip	<b>K10-MT-P0</b>	9293-042-50	<b>\$142</b>
		10 Leads Snap	<b>K10-MT-S0</b>	9293-033-50	<b>\$142</b>

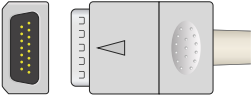
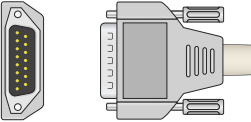
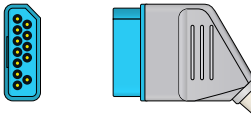

## Nihon Kohden One Piece EKG Cables

Models	Connector	Options	Part Number	OEM #	Price
Cardiofax, 6151, 6851, 6353, 8110, 8330, 8330A, Escape 12, Edan Smart ECG, Danatech, and Dr. Lee EKGs 120B		10 Leads Banana	<b>K10-NK1-B0</b>		<b>\$142</b>
		10 Leads Needle	<b>K10-NK1-N0</b>		<b>\$142</b>
		10 Leads Clip	<b>K10-NK1-P0</b>		<b>\$142</b>
Cardiofax Q, 1350, ECG-1250A, ECG-9620, ECG-9010, ECG-9020, ECG-9022, ECG-9110, ECG-9130, ECG-9132, ECG-9110K, ECG-9130K, Cardioline (new line), Del Mar Reynolds Voyager 12; Newtech 1206; Carewell 1103, Carewell AR 1200ADV		10 Leads Banana	<b>K10-NK2-B0</b>	BA-902D	<b>\$142</b>
		10 Leads Needle	<b>K10-NK2-N0</b>	BA-901D	<b>\$142</b>
		10 Leads Clip	<b>K10-NK2-P0</b>	BA-903D	<b>\$142</b>
		10 Leads Snap	<b>K21009S0</b>		<b>\$142</b>
		10 Leads Clip	<b>K21009P0</b>	BJ-900P	<b>\$142</b>

## Philips HP One Piece EKG Cables

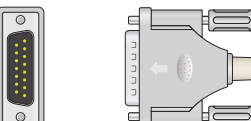
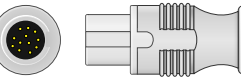
Models	Connector	Options	Part Number	OEM #	Price
M1770A, M1771A, M1772A, PageWriter 100, 200, 200i and Agilent 300i, 300PI; CardioTech CRT-6U, CRT-6D, CRT-6T; Bionet Cardiacare 2000; Delmar Reynolds CardioCollect 12; BLT-08 LT ECG; Spacelabs CardioDirect 12; Woodway Cortex CPX System; Welch Allyn CP 100 and CP 200		10 Leads Banana	<b>K10-HP-B0</b>	M2461A, M3702C, M3703C, 400293 + 401129, 45502-13	<b>\$142</b>
		10 Leads Needle	<b>K10-HP-N0</b>		<b>\$142</b>
		10 Leads Clip	<b>K10-HP-P0</b>		<b>\$142</b>
Codemaster 100		10 Leads Snap	<b>KP-21085S0</b>		<b>\$142</b>
		10 Leads Clip	<b>KP-21085P0</b>		<b>\$142</b>

## Philips HP EKG Leads

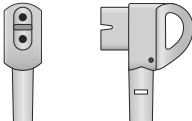
Models	Connector	Options	Part Number	OEM #	Price
Trim, Trim I, Trim II (989803130101), Trim III, PageWriter TC30, PageWriter TC50, PageWriter XLI M1700A, PageWriter XLE 1702A, Touch EKG Machines		10 Leads Banana	<b>LW10-LB0</b>	989803129161, M1713B, M1716B, M1702A	<b>\$134</b>
		10 Leads Clip	<b>LW10-LP0</b>		<b>\$134</b>
		10 Leads Snap	<b>LW10-LS0</b>		<b>\$134</b>
		10 Leads Needle	<b>LW10-LN0</b>		<b>\$134</b>

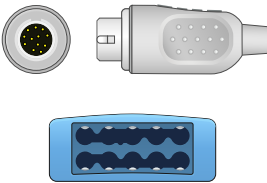

## Philips HP EKG Trunk Cables

Models	Connector	Options	Part Number	OEM #	Price
78352C, 78354C, 78834C Legacy HP Monitors, Modules M1001A/B, M1002A/B, M3001A Opt. C12 or Opt. C18, IntelliVue Multi-Measurement Modules M3002A, Opt. C12, MMS X2, M8102A Opt. C12, MP2 Monitor, M8105A Opt. C12, MP5 Monitor, M3535A/M3536A, HeartStart MRx Defibrillator/Monitor. For use with M1644A (LPA5-90S0) and M1602A (LPB5-90S0) lead set		10 Leads AHA	<b>TP-210850</b>	M1663A, M1949A, M3525A, 989803125831	<b>\$119</b>

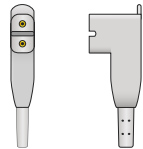
**Physio Control** (See Medtronic)**Quinton EKG Leads**

Models	Connector	Options	Part Number	OEM #	Price
Quinton Q710 stress machine		10 Leads Banana	<b>LT10-LB0</b>	031257-002	<b>\$156</b>
		10 Leads Snap	<b>LT10-LS0</b>		<b>\$156</b>
		10 Leads Clip	<b>LT10-LP0</b>		<b>\$156</b>
		10 Leads Needle	<b>LT10-LN0</b>		<b>\$156</b>

**Quinton One Piece EKG Cables**

Models	Connector	Options	Part Number	OEM #	Price
Burdick/Quinton Q-Stress Treadmill System		10 Leads Banana	<b>K10-BK3-B0</b>		<b>\$240</b>
		10 Leads Snap	<b>K10-BK3-S0</b>	60-00181-01, 60-00185-01	<b>\$240</b>
		10 Leads Clip	<b>K10-BK3-P0</b>	60-00180-01, 60-00184-01, 042051-005	<b>\$240</b>
Burdick/Quinton Q750, Q-4500 systems		10 Leads Banana	<b>K10-QT-B0</b>	019420-003	<b>\$190</b>
		10 Leads Snap	<b>K10-QT-S0</b>		<b>\$190</b>
		10 Leads Clip	<b>K10-QT-P0</b>		<b>\$190</b>

**Schiller One Piece EKG Cables**

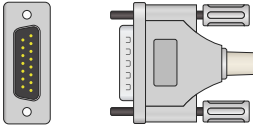
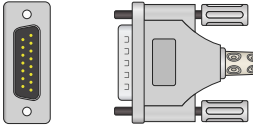
Models	Connector	Options	Part Number	OEM #	Price
AT-1, AT-2, AT-2 Light, AT-2 Plus, AT-4, AT-10, AT-10 Plus, AT-60, AT-101, AT-102, AT-102-Plus, AT-104, AT-110, CS-100, CS-200, MS-2010, MS-2015; Bionet: CardioCare 2000; Esaote: P80 Series 40893, Biosound MyLab 30 CD, 30 CV; Cardiette: AR1200 adv; Welch Allyn CP10, CP20		10 Leads Banana	<b>K10-SH1-B0</b>	2.400095, 2.400071S, 2.40071E, MD07J, 80130-0000, 9293-032-60	<b>\$142</b>
		10 Leads Needle	<b>K10-SH1-N0</b>		<b>\$142</b>
		10 Leads Clip	<b>K10-SH1-P0</b>		<b>\$142</b>
AT3, AT6, CS6, AT5, AT10, AT60, CS-200; Bionet Cardiotouch		10 Leads Banana	<b>K10-SH2-B0</b>		<b>\$142</b>
		10 Leads Needle	<b>K10-SH2-N0</b>		<b>\$142</b>
		10 Leads Clip	<b>K10-SH2-P0</b>		<b>\$142</b>

**Spacelabs One Piece EKG Cables** (Also see Philips HP)

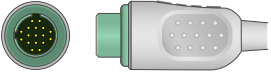
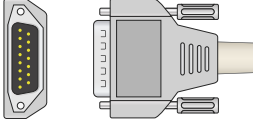
Models	Connector	Options	Part Number	OEM #	Price
		12 Leads Snap	<b>KL-21096S0</b>		<b>\$142</b>
		12 Leads Clip	<b>KL-21096P0</b>		<b>\$142</b>
Spacelabs SL6, Mindray DECG-03A, Edan SE-3, SE-12, SE-12 Express, SE-601A, SE-601B, SE-601C, SE-1010PC, SE-1200, SE-12 Express, ST-1212 and Nihon Kohden BSM-2301K		10 Leads Banana	<b>K10-ED-B0</b>	01.57.107048	<b>\$142</b>
		10 Leads Needle	<b>K10-ED-N0</b>		<b>\$142</b>
		10 Leads Clip	<b>K10-ED-P0</b>		<b>\$142</b>

**Welch Allyn EKG Leads** (Also see Schiller)

Models	Connector	Options	Part Number	OEM #	Price
For use with the 400293 10-lead patient cable on models CP100, CP200		10 Leads Banana	<b>LWA10-LB0</b>	401129	<b>\$95</b>
		10 Leads Snap	<b>LWA10-LS0</b>		<b>\$95</b>
		10 Leads Clip	<b>LWA10-LP0</b>		<b>\$95</b>
		10 Leads Needle	<b>LWA10-LN0</b>		<b>95</b>

**Zoll One Piece EKG Cables**

Models	Connector	Options	Part Number	OEM #	Price
1 Step Patient Cable for E Series and M Series defibrillators. Includes trunk cable and limb and V leads		10 Leads Snap	<b>K21069S0</b>	8000-1007-01, 8000-1007-02	<b>\$240</b>
		10 Leads Clip	<b>K21069P0</b>		<b>\$240</b>



## Limb Electrode Clamps

Details	Connector	Options	Part Number	OEM #	Price
Adult and pediatric extremities, needle (3mm) / banana (4mm) red, black, green and yellow or one single color (green)		Adult Multiple Colors, Box of 4	<b>RU-LC-AO</b>	2029894-001, 714731, 989803101691, 40494E	<b>\$40</b>
		Pediatric Multiple Colors	<b>RU-LC-PO</b>		<b>\$40</b>
		Adult Green, Box of 4	<b>RU-LC-AAO</b>		<b>\$40</b>
		Pediatric Green, Box of 4	<b>RU-LC-PAO</b>		<b>\$40</b>

## Precordial Suction Electrodes

Details	Connector	Options	Part Number	OEM #	Price
Adult and pediatric universal, needle (3mm) / banana (4mm), 6 per box		Adult Blue, Box of 6	<b>RU-SE-AO</b>	40421A, 2029829-001, 714730	<b>\$46</b>
		Pediatric Green, Box of 6	<b>RU-SE-PO</b>		<b>\$40</b>



## EKG Leadwire Adapters

Details	Connector	Options	Part Number	OEM #	Price
Banana (4mm) to Snap		Set of 10 Adapters	<b>AD-BS-100</b>		<b>\$26</b>
Banana (4mm) to Clip		Set of 10 Adapters	<b>AD-BP-100</b>		<b>\$26</b>

## EKG Leadwire Adapters (Continued)

Details	Connector	Options	Part Number	OEM #	Price
Banana (4mm) to "tab" electrodes such as the Nikotab® electrodes		Set of 10 Adapters	<b>AD-BW-100</b>	ADA34, CL-A34, 989803166031, 9490-210, 2056813-010, 9490-214	<b>\$26</b>
Needle (3mm) to "tab" electrodes such as the Nikotab® electrodes		Set of 10 Adapters	<b>AD-NW-100</b>	M2254A, 989803106061	<b>\$26</b>
Banana (4mm) to Snap		Set of 10 Adapters	<b>AD-B-S0</b>		<b>\$26</b>
Banana (4mm) to Clip		Set of 10 Adapters	<b>AD-B-P0</b>	40498E, 989803101701	<b>\$26</b>
Needle (3mm) to Snap		Set of 10 Adapters	<b>AD-N-S0</b>		<b>\$26</b>
Needle (3mm) to Clip		Set of 10 Adapters	<b>AD-N-P0</b>		<b>\$26</b>

## EKG Leadwire Adapters (Continued)

Details	Connector	Options	Part Number	OEM #	Price
Banana (4mm) to Alligator		Set of 10 Adapters	<b>AD-BA-100</b>	ADAK10, 58581-000, 9490-105	<b>\$26</b>
Needle (3mm) to Alligator		Set of 10 Adapters	<b>AD-NA-100</b>	AD125, 98980312931, 9490-106	<b>\$26</b>
Adapter for GE CAM 14, AM4 or AM5 (LQB10-AD0)		Set of 10 Adapters Banana	<b>AD10-DB0</b>	900178-001	<b>\$80</b>
		Set of 10 Adapters Clip	<b>AD10-DP0</b>	900178-003	<b>\$80</b>
		Set of 10 Adapters Snap	<b>AD10-DS0</b>		<b>\$80</b>

## Vet ECG Alligator Electrode Clip

Description	Image	Options	Part Number	OEM #	Price
This reusable electrode is for use with snap leadwires to apply directly on the animal's skin.		Sold by Each	<b>UVC-050</b>	9101-20-58104	<b>\$10</b>

Would one of your colleagues benefit from having a copy of this catalog?  
Please let us know, we'll ship one out! Call us at 866-373-6767.



# NIBP

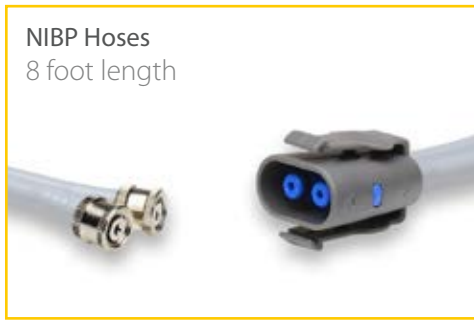

Hoses, reusable and disposable cuffs and connectors



**Bionet** (See Quick-Release NIBP Hose)

**Criticare** (See Nihon Kohden and Quick-Release NIBP Hose)

**Colin** NIBP Hose (Also see Nihon Kohden)



Models	Hose	Options	Part Number	OEM #	Price
		Adult NIBP Hose	<b>AS-31-320</b>	A015ZZ	<b>\$59</b>
		Neonate NIBP Hose	<b>ASN-31-200</b>		<b>\$73</b>

**Corometrics** (See Marquette)

**Critikon** (See Nihon Kohden)



**Datascope** (See Nihon Kohden and Quick-Release NIBP Hose)

**Dinamap** NIBP Hose



Models	Hose	Options	Part Number	OEM #	Price
Dinamap ProCare, Pro Series, Pro 1000 and Critikon Compact BP		Adult NIBP Hose	<b>AD-25-090</b>	107365	<b>\$99</b>
		Neonate NIBP Hose	<b>ADN-25-270</b>	107368	<b>\$99</b>



## Datex Ohmeda NIBP Hose

Models	Hose	Options	Part Number	OEM #	Price
Datex Ohmeda AS/3, CS/3, S/5, Cardiacap 5, Cardiacap II, Light		Adult NIBP Hose	<b>AD-22-17/180</b>	877235	<b>\$99</b>
		Neonate NIBP Hose	<b>ADN-22-270</b>	877514	<b>\$99</b>

## Drager NIBP Hose

Models	Hose	Options	Part Number	OEM #	Price
Siemens Drager SC6000, SC7000, SC8000, SC9000, Infinity Delta, Vista, Kappa, Gamma		Adult NIBP Hose	<b>AS-40-150</b>	MP00953, 1275 275 EH5OU, 1275 275 E07	<b>\$89</b>
		Neonate NIBP Hose	<b>ASN-40-200</b>	2870298	<b>\$92</b>

**Edan** (See Quick-Release NIBP Hose)

**Goldway** (See Quick-Release NIBP Hose)

## Infinium NIBP Hose

Models	Hose	Options	Part Number	OEM #	Price
Omni 2 and Omni 3		Adult NIBP Hose	<b>AS-36-2T0</b>		<b>\$73</b>



**Invivo** (See Nihon Kohden)

**Kontron** (See Nihon Kohden and Quick-Release NIBP Hose)

### Marquette (GE) NIBP Hose

Models	Hose	Options	Part Number	OEM #	Price
Dash, Eagle, Solar, Tram 400, Tram 450, Tram 451, Tram 800, Tram 850, Tram 851, Corometrics 120 and Corometrics 250, Carescape B850		Adult NIBP Hose	<b>AD-24-170</b>	414873-001, 9461-217, 2020980-001, 2017008-001	<b>\$76</b>
		Neonate NIBP Hose	<b>ADN-24-270</b>	414874-001	<b>\$76</b>
Eagle 4000, Solar, Tram 100, Tram 200 and Tram 300		Adult NIBP Hose	<b>AD-22-170</b>	9461-203	<b>\$99</b>
		Neonate NIBP Hose	<b>ADN-22-270</b>	877514	<b>\$99</b>
Eagle 3000, Dash 2000, Dash 3000, Dash 4000, Dash 5000 and Corometrics 120		Adult NIBP Hose	<b>AD-24-090</b>	2017008-003	<b>\$73</b>
		Neonate NIBP Hose	<b>ADN-24-200</b>		<b>\$73</b>

## Medtronic NIBP Hose

Models	Hose	Options	Part Number	OEM #	Price
Lifepak 12 and Lifepak 20		Adult NIBP Hose	<b>AS-12-150</b>		<b>\$59</b>
		Neonate NIBP Hose	<b>ASN-12-200</b>		<b>\$73</b>



**MEK** (See Welch Allyn)

**Mennen** (See Welch Allyn)



**Mindray** (See Quick-Release NIBP Hose)

**Nellcor** (See Quick-Release NIBP Hose)



## Nihon Kohden NIBP Hose

Models	Hose	Options	Part Number	OEM #	Price
		Adult NIBP Hose	<b>AD-09-090</b>	8841	<b>\$99</b>
		Neonate NIBP Hose	<b>ADN-09-270</b>	8840	<b>\$99</b>
Life Scope OPV 1500K, BSM-2351A, BSM-4102, BSM-4102A, Life Scope TR, BSM-6000 series, BSM-6301K, BSM-6501K, BSM-6701K, Life Scope J, BSM-9101, PVM-2701		Adult NIBP Hose	<b>AD-30-180</b>	YN-900P, YN-901P	<b>\$73</b>
		Neonate NIBP Hose	<b>AND-30-200</b>	YN-920P, YN-921P	<b>\$73</b>

## Nihon Kohden NIBP Hose (Continued)



Models	Hose	Options	Part Number	OEM #	Price
Nihon Kohden, Criticare: 507E/P/R, 507N/P, 507S/SD, 507O/P, 1100, 2200; Datascope, Colin, Welch Allyn		Adult NIBP Hose	<b>AS-04-070</b>	709	<b>\$59</b>
		Neonate NIBP Hose	<b>ASN-04-200</b>		<b>\$73</b>

## Philips NIBP Hose (Also see Quick-Release NIBP Hose)

Models	Hose	Options	Part Number	OEM #	Price
M1008B and all Philips monitors except for A1 and A3		Adult NIBP Hose	<b>AS-16-150</b>	M1599A, M1599B, M1598B, 989803104341	<b>\$66</b>
		Neonate NIBP Hose	<b>ASN-16-200</b>	M1596B, M1597B	<b>\$79</b>

## Physio Control (See Medtronic)



## Quick-Release NIBP Hose

Models	Hose	Options	Part Number	OEM #	Price
Bionet: BMP300; Criticare: 506 series, 507EL/C, 507NJC, 507MPS, 8100 series; Datascope: Accutorr V, Duo, Passport 2, Passport V, Spectrum, Spectrum OR, Trio, V12, V21; Edan; Goldway; Kontron; Mindray T5; Nellcor; Ohmeda: enGuard CMS; Penlon; Philips: A1 and A3; Siemens; Spacelabs		Adult NIBP Hose	<b>AS-15-150</b>	200683-04-0003, 200683-04-0004, 509B-30-06259, 0683-00-0189-80, 705, 706, 708, M3918A, 714-0060-00, 714-0061-00, 714-0018-00	<b>\$66</b>
		Neonate NIBP Hose	<b>ASN-15-200</b>	708	<b>\$79</b>

**Siemens** (See Drager and Quick-Release NIBP Hose)

**Spacelabs** (Also see Quick-Release NIBP Hose)

**Welch Allyn** NIBP Hose (Also see Nihon Kohden)

Models	Hose	Options	Part Number	OEM #	Price
MEK MP 700, MP 1000 and Welch Allyn Propaq Encore		Adult NIBP Hose	<b>AS-09-090</b>		<b>\$59</b>
		Neonate NIBP Hose	<b>ASN-09-200</b>		<b>\$73</b>
Welch Allyn Atlas and Mennen monitors		Adult NIBP Hose	<b>AS-04-090</b>		<b>\$59</b>
		Neonate NIBP Hose	<b>ASN-04-200</b>		<b>\$73</b>
Spot Vital Signs LXi		Adult NIBP Hose	<b>AD-41-090</b>	4500-32	<b>\$73</b>

**Zoll** NIBP Hose

Models	Hose	Options	Part Number	OEM #	Price
M Series and E Series defibrillators		Adult NIBP Hose	<b>AS-15-170</b>	8000-0655, 8000-0662	<b>\$53</b>
		Neonate NIBP Hose	<b>ASN-15-200</b>		<b>\$73</b>

## Reusable NIBP Cuffs

Description	Hose	Options	Part Number	Price
Universal, reusable cuffs, sold individually. Connectors sold separately.		Adult (25 - 35cm) Single Hose	<b>F1880S0</b>	<b>\$20</b>
		Adult (25 - 35cm) Double Hose	<b>F1880D0</b>	<b>\$20</b>
		Large Adult (33-47cm) Single Hose	<b>F1869S0</b>	<b>\$20</b>
		Large Adult (33-47cm) Double Hose	<b>F1869D0</b>	<b>\$20</b>
		Small Adult (17-26cm) Single Hose	<b>F1885S0</b>	<b>\$20</b>
		Small Adult (17-26cm) Double Hose	<b>F1885D0</b>	<b>\$20</b>
		Pediatric (18-26cm) Single Hose	<b>F1881S0</b>	<b>\$20</b>
		Pediatric (18-26cm) Double Hose	<b>F1881D0</b>	<b>\$20</b>
		Infant (10-19cm) Single Hose	<b>F1882S0</b>	<b>\$20</b>
		Infant (10-19cm) Double Hose	<b>F1882D0</b>	<b>\$20</b>
		Neonate (6-11cm) Single Hose	<b>F1883S0</b>	<b>\$20</b>
		Neonate (6-11cm) Double Hose	<b>F1883D0</b>	<b>\$20</b>
		Thigh (46-66cm) Single Hose	<b>F1884S0</b>	<b>\$30</b>
		Thigh (46-66cm) Double Hose	<b>F1884D0</b>	<b>\$30</b>

## Neonate Disposable NIBP Cuffs

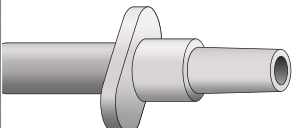
Description	Hose	Options	Part Number	Price
Disposable neonate NIBP cuffs in 5 sizes, sold in cases of 10 units.		Single Hose #1 (3-6cm)	<b>F1781S-C05-100</b>	<b>\$20</b>
		Double Hose #1 (3-6cm)	<b>F1781D-C05-100</b>	<b>\$20</b>
		Single Hose #2 (4-8cm)	<b>F1782S-C05-100</b>	<b>\$20</b>
		Double Hose #2 (4-8cm)	<b>F1782D-C05-100</b>	<b>\$20</b>
		Single Hose #3 (6-11cm)	<b>F1783S-C05-100</b>	<b>\$20</b>
		Double Hose #3 (6-11cm)	<b>F1783D-C05-100</b>	<b>\$20</b>
		Single Hose #4 (7-13cm)	<b>F1784S-C05-100</b>	<b>\$20</b>
		Double Hose #4 (7-13cm)	<b>F1784D-C05-100</b>	<b>\$20</b>
		Single Hose #5 (8-15cm)	<b>F1785S-C05-100</b>	<b>\$20</b>
		Double Hose #5 (8-15cm)	<b>F1785D-C05-100</b>	<b>\$20</b>

## All Size Disposable NIBP Cuffs

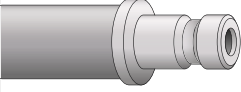
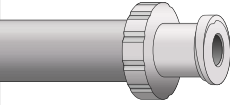
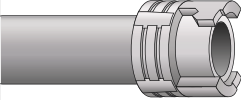
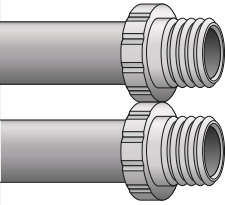
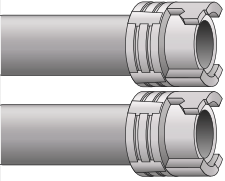
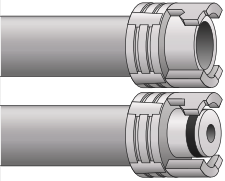
Description	Hose	Options	Part Number	Price
<p>Datascope, Drager, Philips, Siemens, and Spacelabs monitors. Sold in cases of 5 units. Each cuff comes with a molded BP12 plastic NIBP connector.</p> 		Adult (23-33cm) Single Hose	<b>F1740S-C12-050</b>	<b>\$20</b>
		Large Adult (31-40cm) Single Hose	<b>F1720S-C12-050</b>	<b>\$22</b>
		Small Adult (17-25cm) Single Hose	<b>F1750S-C12-050</b>	<b>\$20</b>
		Pediatric (12-19cm) Single Hose Cuff	<b>F1760S-C12-050</b>	<b>\$18</b>
		Infant (8-13cm) Single Hose	<b>F1770S-C12-050</b>	<b>\$18</b>
		Thigh (38-50cm) Single Hose	<b>F1790S-C12-050</b>	<b>\$35</b>
<p>Colin, Datascope and Spacelabs monitors. Available in cases of 5 units. Each cuff comes with a molded BP03 plastic NIBP connector.</p> 		Adult (23-33cm) Single Hose	<b>F1740S-C03-050</b>	<b>\$20</b>
		Large Adult (31-40cm) Single Hose	<b>F1720S-C03-050</b>	<b>\$22</b>
		Small Adult (17-25cm) Single Hose	<b>F1750S-C03-050</b>	<b>\$20</b>
		Pediatric (12-19cm) Single Hose Cuff	<b>F1760S-C03-050</b>	<b>\$18</b>
		Infant (8-13cm) Single Hose	<b>F1770S-C03-050</b>	<b>\$18</b>
		Thigh (38-50cm) Single Hose	<b>F1790S-C03-050</b>	<b>\$35</b>
<p>Available in cases of 5 units. Each cuff comes with a molded BP18 plastic NIBP connector.</p> 		Adult (23-33cm) Single Hose	<b>F1740S-C18-050</b>	<b>\$20</b>
		Large Adult (31-40cm) Single Hose	<b>F1720S-C18-050</b>	<b>\$22</b>
		Small Adult (17-25cm) Single Hose	<b>F1750S-C18-050</b>	<b>\$20</b>
		Pediatric (12-19cm) Single Hose Cuff	<b>F1760S-C18-050</b>	<b>\$18</b>
		Infant (8-13cm) Single Hose	<b>F1770S-C18-050</b>	<b>\$18</b>
		Thigh (38-50cm) Single Hose	<b>F1790S-C18-050</b>	<b>\$35</b>
<p>GE Corometrics, Dinamap and MDE monitors. Available in cases of 5 units. Each hose comes with a molded BP08 plastic NIBP connector incorporated.</p> 		Adult (23-33cm) Double Hose	<b>F1740D-C0808-050</b>	<b>\$20</b>
		Large Adult (31-40cm) Double Hose	<b>F1720D-C0808-050</b>	<b>\$22</b>
		Small Adult (17-25cm) Double Hose	<b>F1750D-C0808-050</b>	<b>\$20</b>
		Pediatric (12-19cm) Double Hose	<b>F1760D-C0808-050</b>	<b>\$18</b>
		Infant (8-13cm) Double Hose	<b>F1770D-C0808-050</b>	<b>\$18</b>
		Thigh (38-50cm) Double Hose	<b>F1790D-C0808-050</b>	<b>\$35</b>
<p>GE Eagle, Dash, Tram, Solar and MAC-LAB monitors. Available in cases of 5 units. Each hose comes with a molded BP18 plastic NIBP connector incorporated.</p> 		Adult (23-33cm) Double Hose	<b>F1740D-C1818-050</b>	<b>\$20</b>
		Large Adult (31-40cm) Double Hose	<b>F1720D-C1818-050</b>	<b>\$22</b>
		Small Adult (17-25cm) Double Hose	<b>F1750D-C1818-050</b>	<b>\$20</b>
		Pediatric (12-19cm) Double Hose	<b>F1760D-C1818-050</b>	<b>\$18</b>
		Infant (8-13cm) Double Hose	<b>F1770D-C1818-050</b>	<b>\$18</b>
		Thigh (38-50cm) Double Hose	<b>F1790D-C1818-050</b>	<b>\$35</b>
<p>Datex Ohmeda monitors. Available in cases of 5 units. Each hose comes with a molded BP17 and BP18 plastic NIBP connector.</p> 		Adult (23-33cm) Double Hose	<b>F1740D-C1718-050</b>	<b>\$20</b>
		Large Adult (31-40cm) Double Hose	<b>F1720D-C1718-050</b>	<b>\$22</b>
		Small Adult (17-25cm) Double Hose	<b>F1750D-C1718-050</b>	<b>\$20</b>
		Pediatric (12-19cm) Double Hose	<b>F1760D-C1718-050</b>	<b>\$18</b>
		Infant (8-13cm) Double Hose	<b>F1770D-C1718-050</b>	<b>\$18</b>
		Thigh (38-50cm) Double Hose	<b>F1790D-C1718-050</b>	<b>\$35</b>

## NIBP Connectors



Connector	Image Src	Description	Part Number	Price
BP03 NIBP Connector		NIBP luer-lock connector for use with Mennen (Old), Shchiller, Spacelabs (Old). Connects to BP06	<b>BP03</b>	<b>\$4</b>
BP04 NIBP Connector		NIBP luer-style connector for use with Mennen (Old), Shchiller, Spacelabs (Old). Connects to BP07.	<b>BP04</b>	<b>\$6</b>
BP05 NIBP Connector		NIBP connector for use with CAS Med, Drager, Kontron, Physio Control (Old), Schiller. Connects to BP20. Generally used for neonate cuffs.	<b>BP05</b>	<b>\$4</b>
BP06 NIBP Connector		NIBP connector for use with BCI (Older versions), Datascope (Older versions). Connects to BP03.	<b>BP06</b>	<b>\$4</b>
BP07 NIBP Connector		NIBP connector for use with BCI (Older versions), Datascope (Older versions). Connects to BP04.	<b>BP07</b>	<b>\$6</b>
BP08 NIBP Connector		NIBP connector for use with Critikon, Invivo (requires 2), Kontron (requires 2), Mennen (requires 2), Nihon Kohden (requires 2), Welch Allyn. Connects to BP09.	<b>BP08</b>	<b>\$4</b>
BP09 NIBP Connector		NIBP threaded connector for use with Critikon, Invivo (requires 2), Kontron (requires 2), Mennen (requires 2), Nihon Kohden (requires 2), Welch Allyn. Connects to BP08.	<b>BP09</b>	<b>\$4</b>
BP12 NIBP Connector		NIBP connector for use with Criticare, Datascope, Drager, Siemens, Physio Control, Mindray, Philips, Spacelabs. Connects to BP15.	<b>BP12</b>	<b>\$4</b>
BP12-P NIBP Connector		NIBP connector for use with Criticare, Datascope, Drager, Siemens, Physio Control, Mindray, Philips, Spacelabs. Connects to BP15.	<b>BP12-P</b>	<b>\$4</b>



## NIBP Connectors (Continued)

Connector	Image Src	Description	Part Number	Price
BP15 NIBP Connector		NIBP bayonet-style connector for use with Schiller and Infinium One. Connects to BP12.	<b>BP15</b>	<b>\$7</b>
BP16 NIBP Connector		NIBP connector for use with Philips. Connects to Philips monitors.	<b>BP16</b>	<b>\$7</b>
BP17 NIBP Connector		NIBP quick-connect connector for use with Datex Ohmeda, Marquette, Zoll M Series. Connects to BP18.	<b>BP17</b>	<b>\$4</b>
BP18 NIBP Connector		NIBP quick-connect connector for use with Datex Ohmeda, Marquette, Zoll M Series. Connects to BP17.	<b>BP18</b>	<b>\$4</b>
BP20 NIBP Connector		NIBP connector for use with neonate NIBP Hoses. Connects to BP05.	<b>BP20</b>	<b>\$5</b>
BP21 NIBP Connector		NIBP connector for use with Pace Tech monitors.	<b>BP21</b>	<b>\$4</b>
BS21 NIBP Connector		BS21 monitor socket. Connects to BP21.	<b>BS21</b>	<b>\$10</b>
BP22 NIBP Connector		NIBP connector for use with GE Datex AS/3, CS/3, S/5, Cardiocap 5, Cardiocap II, Eagle 4000, Solar, Tram monitors.	<b>BP22</b>	<b>\$10</b>
BP25 NIBP Connector		NIBP connector for use with Dinamap monitors.	<b>BP25</b>	<b>\$10</b>

## NIBP Connectors (Continued)

Connector	Image Src	Description	Part Number	Price
BP31 NIBP Connector		NIBP connector for use with Colin monitors.	<b>BP31</b>	<b>\$6</b>
BP32 NIBP Connector		NIBP connector for use with Colin monitors.	<b>BP32</b>	<b>\$6</b>
"Y" NIBP Connector		"Y" NIBP adapter to convert a double NIBP hose to a single NIBP hose.	<b>BP3T-Y0</b>	<b>\$8</b>



**IBP Adapters**  
13 foot cable, connects to disposable transducer



**IBP Converters**  
1 foot cable



**Transducers**  
Sterile, single-use, safely disposable



**Pressure Infusion Bags**  
Disposable and reusable options



# IBP

Compatible IBP adapters, converter cables and disposable transducers

# Choosing your IBP adapter cable

IBP adapters are available with the following connectors for use with all of the major disposable transducer brands:

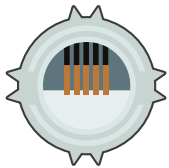

Argon

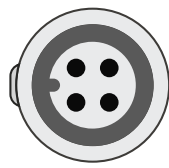

B. Brown

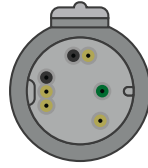

BD

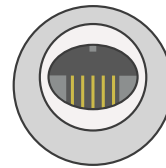

Edwards

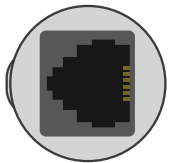

Medex Abbott

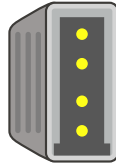

Utah



Medex Logical

## 6-Pin IBP Adapter

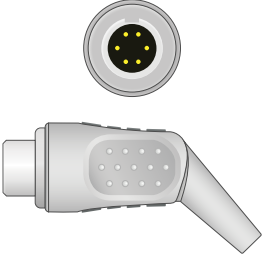
Models	Adapter	Options	Part Number	OEM #	Price
IBP adapter cable for Bard H8000 Intra Aortic Balloon Pump (No Cal); BCI 9100 Series and 9200 Advisor Series; Critikon; Digicare; Dixtal DX-2020, DX-2021, and DX-2023; Genera 710C; Hewlett Packard 5microvolt, (Option 002) 8805, 78205; Invivo Corporation/Medical Data Electronics (NDE), Inc. TVS Omnitrak, Omnitrak 4000, Millenia, Model 3550 Escort M12, Escort 100 - 200 - and 300 Series, MDE, Series 3100 - 3500; Ivy Biomedical 700, 400 Series; Medical Research Laboratories - Welch Allyn Portable Invasive Care (PIC); Mindray / Datascope Passport; Mennen; Nellcor Escort; Omni-Trak 4000; PaceTech VitalMax 4000 Modular; Physio Control Lifepak 12; Smiths Medical; Spacelabs 300, 400, 500, 600, Alpha 7, Alpha PC, 90308, 90311, 90331, 90402, 90403, 90470, 90496*, 90603A, 91496*, PC Express, 700 Surgical Series, MOD-CD, Tel/Vitatek, Scout TPC *90496 and 91496 require Spacelabs 700-0028-00 rectangular jumper cable; Tecktronix 400 Series; Vitalert 2000; Viatek; Welch Allyn Propaq 102, 104, 106 Acuity, 106EL, Encore; Zoll Defibrillators		For Argon Transducers	<b>IC-6P-AG0</b>		<b>\$87</b>
		For B. Braun Transducers	<b>IC-6P-BB0</b>		<b>\$87</b>
		For BD Transducers	<b>IC-6P-BD0</b>	001C-30-70758, 684085	<b>\$87</b>
		For Edwards Transducers	<b>IC-6P-ED0</b>	0010-21-43094	<b>\$87</b>
		For Medex Abbott Transducers	<b>IC-6P-MX0</b>		<b>\$87</b>
		For Utah Transducers	<b>IC-6P-UT0</b>	650-208	<b>\$87</b>
		For Medex Logical Transducers	<b>IC-6P-MX10</b>		<b>\$87</b>

**Air Shields** (See Datex Ohmeda)

**BCI** (See 6-Pin IBP Adapter)

**Burdick** (See Datex Ohmeda)

**Colin** (See Datascope)

## Criticare IBP Adapter

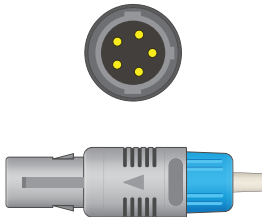
Models	Adapter	Options	Part Number	OEM #	Price
Criticare Matrix, Scholar 2200		For Argon Transducers	<b>IC-CSI-AG0</b>		<b>\$87</b>
		For B. Braun Transducers	<b>IC-CSI-BB0</b>		<b>\$87</b>
		For BD Transducers	<b>IC-CSI-BD0</b>	684175	<b>\$87</b>
		For Edwards Transducers	<b>IC-CSI-ED0</b>		<b>\$87</b>
		For Medex Abbott Transducers	<b>IC-CSI-MX0</b>		<b>\$87</b>
		For Utah Transducers	<b>IC-CSI-UT0</b>		<b>\$87</b>
		For Medex Logical Transducers	<b>IC-CSI-MX10</b>		<b>\$87</b>

**Critikon** (See 6-Pin IBP Adapter)

**Datascope IBP Adapter** (Also see 6-Pin IBP Adapter)

Models	Adapter	Options	Part Number	OEM #	Price
American Optical 1131 Module; Colin 408BP, 400 Series; CWE Research Lab Monitor; Datascope System IA Balloon Pump 95, 97, 98, 98XT, CS100, CS300, 2000, 2000A, 2001, 2002, 3000, Passport, Passport II, Passport XG, Spectrum, Spectrum OR, Trio; Hewlett Packard Sandborn, INEX; Kontron (Roche) 2106, 7320, 7324 (BP Module for 7046 & 7048); Marquette 3100 Series		For Argon Transducers	<b>IC-DT-AG0</b>		<b>\$87</b>
		For B. Braun Transducers	<b>IC-DT-BB0</b>		<b>\$87</b>
		For BD Transducers	<b>IC-DT-BD0</b>	684078	<b>\$87</b>
		For Edwards Transducers	<b>IC-DT-ED0</b>		<b>\$87</b>
		For Medex Abbott Transducers	<b>IC-DT-MX0</b>		<b>\$87</b>
		For Utah Transducers	<b>IC-DT-UT0</b>	650-204	<b>\$87</b>
		For Medex Logical Transducers	<b>IC-DT-MX10</b>		<b>\$87</b>
Datascope Passport V, V12, V21		For Argon Transducers	<b>IC-DT1-AG0</b>		<b>\$87</b>
		For B. Braun Transducers	<b>IC-DT1-BB0</b>		<b>\$87</b>
		For BD Transducers	<b>IC-DT1-BD0</b>	040-000053-00	<b>\$87</b>
		For Edwards Transducers	<b>IC-DT1-ED0</b>	040-000054-00	<b>\$87</b>
		For Medex Abbott Transducers	<b>IC-DT1-MX0</b>		<b>\$87</b>
		For Utah Transducers	<b>IC-DT1-UT0</b>		<b>\$87</b>
		For Medex Logical Transducers	<b>IC-DT1-MX10</b>		<b>\$87</b>

**Datex Ohmeda IBP Adapter**

Models	Adapter	Options	Part Number	OEM #	Price
Air-Shields AS-100 (141 Module), AS-441; Burdick M500 Series M544 Module (M560/M565/M575 Mainframe); Diascope Traveler/North American; GE Datex Ohmeda AS/3, AS/5, ESTP Module, CC-104, Cardiopac CM-104, Cardiopac I and II, Cardiopac 5; Kone M500 Series M544 Module (M560/ M565/ M575 Mainframe); Puritan - Bennett PB 240, PB 245, PB 245P; Simonson & Weil AS100 Series, Athena System, 8000 Quadrascope		For Argon Transducers	<b>IC-DX-AG0</b>		<b>\$87</b>
		For B. Braun Transducers	<b>IC-DX-BB0</b>		<b>\$87</b>
		For BD Transducers	<b>IC-DX-BD0</b>		<b>\$87</b>
		For Edwards Transducers	<b>IC-DX-ED0</b>	684104	<b>\$87</b>
		For Medex Abbott Transducers	<b>IC-DX-MX0</b>		<b>\$87</b>
		For Utah Transducers	<b>IC-DX-UT0</b>	650-217	<b>\$87</b>
		For Medex Logical Transducers	<b>IC-DX-MX10</b>		<b>\$87</b>

**Drager IBP Adapter**

Models	Adapter	Options	Part Number	OEM #	Price
Siemens Axiom Sensis XP with Hemopod, 3rds Generation Sirecust 400 Series, 630, 700, 732, 960, 961, 1241, 1260, 1280, 1281, 4041, SC6000, SC6002, SC6002 XL, SC6802 XL, Gamma XL, Vista XL, SC7000, SC8000, SC9000, SC9000 XL, Delta, Delta XL		For Argon Transducers	<b>IC-SM1-AG0</b>		<b>\$87</b>
		For B. Braun Transducers	<b>IC-SM1-BB0</b>		<b>\$87</b>
		For BD Transducers	<b>IC-SM1-BD0</b>	684082	<b>\$87</b>
		For Edwards Transducers	<b>IC-SM1-ED0</b>		<b>\$87</b>
		For Medex Abbott Transducers	<b>IC-SM1-MX0</b>		<b>\$87</b>
		For Utah Transducers	<b>IC-SM1-UT0</b>	650-203	<b>\$87</b>
		For Medex Logical Transducers	<b>IC-SM1-MX10</b>		<b>\$87</b>

## Drager IBP Adapter (Continued)

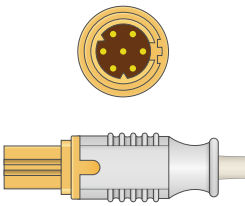
Models	Adapter	Options	Part Number	OEM #	Price
Drager Infinity Vista, Delta Kappa		For Argon Transducers	<b>IC-SM2-AGO</b>		<b>\$87</b>
		For B. Braun Transducers	<b>IC-SM2-BB0</b>		<b>\$87</b>
		For BD Transducers	<b>IC-SM2-BD0</b>	MS22148, 3375933	<b>\$87</b>
		For Edwards Transducers	<b>IC-SM2-ED0</b>	MS22147	<b>\$87</b>
		For Medex Abbott Transducers	<b>IC-SM2-MX0</b>	MS22535	<b>\$87</b>
		For Utah Transducers	<b>IC-SM2-UT0</b>	MS22534	<b>\$87</b>
		For Medex Logical Transducers	<b>IC-SM2-MX10</b>		<b>\$87</b>

## Marquette (GE) IBP Adapter

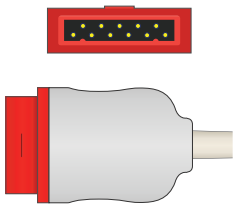
Models	Adapter	Options	Part Number	OEM #	Price
GE Marquette Eagle, Dash 1000, Dash 2000, Dash 3000, Dash 3100, Dash 4000, Solar 7000, Solar 8000, Solar 9000, Tram Module 100-600, Cath Lab, MAC-Lab, Tram Scope 100-800 A or L Series, Tram Rac 3, Tram Rac 4A; Datex Ohmeda AM Module E-PRESTN		For Argon Transducers	<b>IC-MQ-AGO</b>		<b>\$87</b>
		For B. Braun Transducers	<b>IC-MQ-BB0</b>	22339301	<b>\$87</b>
		For BD Transducers	<b>IC-MQ-BD0</b>	700077-001, 684102	<b>\$87</b>
		For Edwards Transducers	<b>IC-MQ-ED0</b>	2021197-001	<b>\$87</b>
		For Medex Abbott Transducers	<b>IC-MQ-MX0</b>	700075-001	<b>\$87</b>
		For Utah Transducers	<b>IC-MQ-UT0</b>	700078-001, 650-236	<b>\$87</b>
		For Medex Logical Transducers	<b>IC-MQ-MX10</b>		<b>\$87</b>

## Hellige IBP Adapter

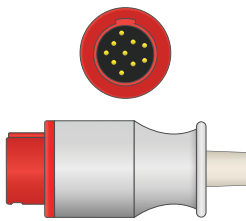
Models	Adapter	Options	Part Number	OEM #	Price
		For Argon Transducers	<b>IC-HL-AGO</b>		<b>\$87</b>
		For B. Braun Transducers	<b>IC-HL-BB0</b>		<b>\$87</b>
		For BD Transducers	<b>IC-HL-BD0</b>		<b>\$87</b>
		For Edwards Transducers	<b>IC-HL-ED0</b>		<b>\$87</b>
		For Medex Abbott Transducers	<b>IC-HL-MX0</b>		<b>\$87</b>
		For Utah Transducers	<b>IC-HL-UT0</b>		<b>\$87</b>
		For Medex Logical Transducers	<b>IC-HL-MX10</b>		<b>\$87</b>

## Infinium IBP Adapter

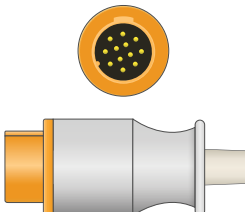
Models	Adapter	Options	Part Number	OEM #	Price
Arrow KAAT I Plus and II Plus; DRE Waveline and Vida; Infinium Procyon and Vega; Kontron Minimon, Supermon, Fetalmon 2B Fetalogic 4000, K2000, IAB Balloon Pump, 7000 Series, Aero KAAT II Plus		For Argon Transducers	<b>IC-KTN-AGO</b>		<b>\$87</b>
		For B. Braun Transducers	<b>IC-KTN-BB0</b>		<b>\$87</b>
		For BD Transducers	<b>IC-KTN-BD0</b>		<b>\$87</b>
		For Edwards Transducers	<b>IC-KTN-ED0</b>		<b>\$87</b>
		For Medex Abbott Transducers	<b>IC-KTN-MX0</b>		<b>\$87</b>
		For Utah Transducers	<b>IC-KTN-UT0</b>	650-230	<b>\$87</b>
		For Medex Logical Transducers	<b>IC-KTN-MX10</b>		<b>\$87</b>

**Invivo** (See 6-Pin IBP Adapter)

**IVY Biomedical** (See 6-Pin IBP Adapter)

**Kontron** (See Infinium)

**Medtronic** (See 6-Pin IBP Adapter)

### MEK IBP Adapter

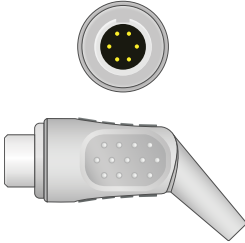
Models	Adapter	Options	Part Number	OEM #	Price
		For Argon Transducers	<b>IC-MEK-AGO</b>		<b>\$87</b>
		For B. Braun Transducers	<b>IC-MEK-BBO</b>		<b>\$87</b>
		For BD Transducers	<b>IC-MEK-BDO</b>		<b>\$87</b>
		For Edwards Transducers	<b>IC-MEK-EDO</b>		<b>\$87</b>
		For Medex Abbott Transducers	<b>IC-MEK-MX0</b>		<b>\$87</b>
		For Utah Transducers	<b>IC-MEK-UTO</b>		<b>\$87</b>
		For Medex Logical Transducers	<b>IC-MEK-MX10</b>		<b>\$87</b>

### Mennen IBP Adapter (Also see 6-Pin IBP Adapter)

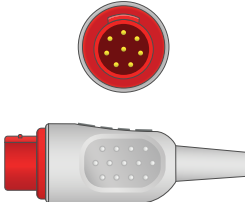
Models	Adapter	Options	Part Number	OEM #	Price
Mennen Envoy and Vitalogik 5500		For Argon Transducers	<b>IC-MN-AGO</b>		<b>\$87</b>
		For B. Braun Transducers	<b>IC-MN-BBO</b>		<b>\$87</b>
		For BD Transducers	<b>IC-MN-BDO</b>	684248	<b>\$87</b>
		For Edwards Transducers	<b>IC-MN-EDO</b>		<b>\$87</b>
		For Medex Abbott Transducers	<b>IC-MN-MX0</b>		<b>\$87</b>
		For Utah Transducers	<b>IC-MN-UTO</b>		<b>\$87</b>
		For Medex Logical Transducers	<b>IC-MN-MX10</b>		<b>\$87</b>

### Mindray IBP Adapter (Also see 6-Pin IBP Adapter)

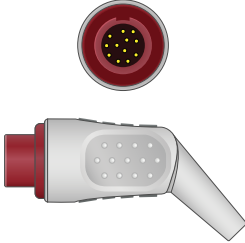
Models	Adapter	Options	Part Number	OEM #	Price
Beneview T5, T6, T8, DPM6, DPM7		For Argon Transducers	<b>IC-MR-AGO</b>		<b>\$87</b>
		For B. Braun Transducers	<b>IC-MR-BBO</b>		<b>\$87</b>
		For BD Transducers	<b>IC-MR-BDO</b>	001C-30-70757	<b>\$87</b>
		For Edwards Transducers	<b>IC-MR-EDO</b>	0010-21-12179	<b>\$87</b>
		For Medex Abbott Transducers	<b>IC-MR-MX0</b>		<b>\$87</b>
		For Utah Transducers	<b>IC-MR-UTO</b>	650-206	<b>\$87</b>
		For Medex Logical Transducers	<b>IC-MR-MX10</b>		<b>\$87</b>

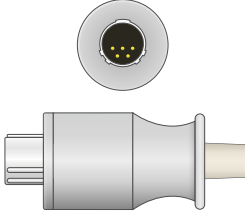
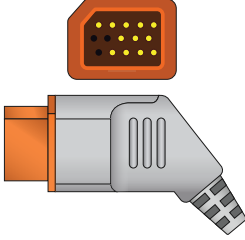

## Nihon Kohden IBP Adapter

Models	Adapter	Options	Part Number	OEM #	Price
Life Scope BSM: 1100 series, 1200 series, 1230A, 2100 series, 2300* series, 3100 series, 4100* series, 5100* series, 7100 series, 7200 series, 8300 series, 8500 series, 8800 series, 9500* series. Life Scope BSS 9800* series. Life Scope 8, 9, 11, 12, 14. Life Scope OEC 6000 and 7000 series. Life Scope OMP. *Requires adapter cable JP-910P from Nihon Kohden		For Argon Transducers	<b>IC-NK1-AG0</b>		<b>\$87</b>
		For B. Braun Transducers	<b>IC-NK1-BB0</b>		<b>\$87</b>
		For BD Transducers	<b>IC-NK1-BD0</b>	684090	<b>\$87</b>
		For Edwards Transducers	<b>IC-NK1-ED0</b>		<b>\$87</b>
		For Medex Abbott Transducers	<b>IC-NK1-MX0</b>		<b>\$87</b>
		For Utah Transducers	<b>IC-NK1-UT0</b>	650-225	<b>\$87</b>
		For Medex Logical Transducers	<b>IC-NK1-MX10</b>		<b>\$87</b>
Life Scope TR, BSM-6000 series, BSM-6301K, BSM-6501K, BSM-6701K, BSM-9101K, Life Scope J		For Argon Transducers	<b>IC-NK2-AG0</b>		<b>\$87</b>
		For B. Braun Transducers	<b>IC-NK2-BB0</b>		<b>\$87</b>
		For BD Transducers	<b>IC-NK2-BD0</b>	JP-900P	<b>\$87</b>
		For Edwards Transducers	<b>IC-NK2-ED0</b>	JP-902P	<b>\$87</b>
		For Medex Abbott Transducers	<b>IC-NK2-MX0</b>		<b>\$87</b>
		For Utah Transducers	<b>IC-NK2-UT0</b>		<b>\$87</b>
		For Medex Logical Transducers	<b>IC-NK2-MX10</b>		<b>\$87</b>

## Pace Tech (See 6-Pin IBP Adapter)

## Philips IBP Adapter

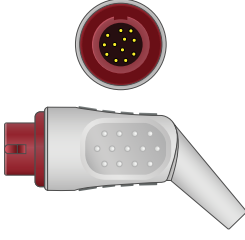
Models	Adapter	Options	Part Number	OEM #	Price
78341A, 78342A, 78352A, M1165A, 78354C, 78205A-D, Merlin, Viridia 24, CMS 24, V26, M2, M3, M4, M1006A/B, M1026A, M1166A, M1175A, M1350B, M1205A, M1350A, M1353A, 8030A, 8040A, 3536A, all HP Monitors Model # XX, MXXXXA M1006A - BPM Module, M1006B, Merlin 1300, Omnicare M1006A to M1176A		For Argon Transducers	<b>IC-HP-AG0</b>		<b>\$87</b>
		For B. Braun Transducers	<b>IC-HP-BB0</b>	M1634A	<b>\$87</b>
		For BD Transducers	<b>IC-HP-BD0</b>	684081	<b>\$87</b>
		For Edwards Transducers	<b>IC-HP-ED0</b>		<b>\$87</b>
		For Medex Abbott Transducers	<b>IC-HP-MX0</b>		<b>\$87</b>
		For Utah Transducers	<b>IC-HP-UT0</b>	650-206	<b>\$87</b>
		For Medex Logical Transducers	<b>IC-HP-MX10</b>		<b>\$87</b>

## Physio Control (See 6-Pin IBP Adapter)

## Siemens (See Drager)

## Spacelabs IBP Adapter (Also see 6-Pin IBP Adapter)

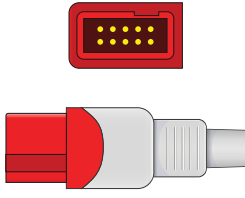
Models	Adapter	Options	Part Number	OEM #	Price
Ultraview		For Argon Transducers	<b>IC-SL-AG0</b>		<b>\$87</b>
		For B. Braun Transducers	<b>IC-SL-BB0</b>		<b>\$87</b>
		For BD Transducers	<b>IC-SL-BD0</b>		<b>\$87</b>
		For Edwards Transducers	<b>IC-SL-ED0</b>		<b>\$87</b>
		For Medex Abbott Transducers	<b>IC-SL-MX0</b>		<b>\$87</b>
		For Utah Transducers	<b>IC-SL-UT0</b>		<b>\$87</b>
		For Medex Logical Transducers	<b>IC-SL-MX10</b>		<b>\$87</b>

## Welch Allyn (See 6-Pin IBP Adapter)

## Zoll (See 6-Pin IBP Adapter)

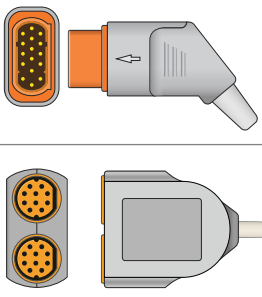
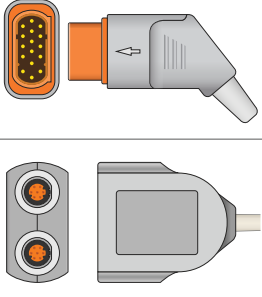
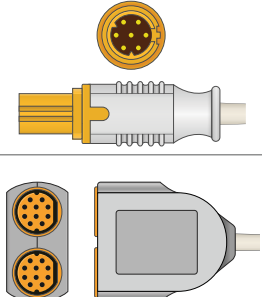
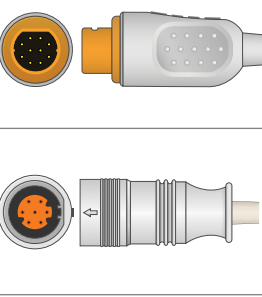
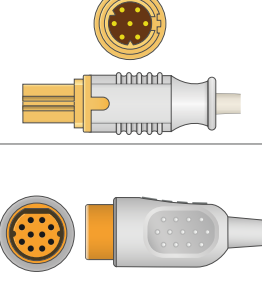

Dräger IBP Converter

Specification	Converter	Options	Part Number	OEM #	Price
IBP converter cable used for converting a Spacelabs IBP connector to two Siemens 10-Pin adapter cables. 1 foot cable.		IBP Converter Cable	<b>IC-S-SM1/20</b>	5731281	<b>\$157</b>
IBP converter cable used for converting a Spacelabs IBP connector to two Siemens 6-Pin adapter cables. 1 foot cable.		IBP Converter Cable	<b>IC-S-SM2/20</b>	5592147	<b>\$157</b>
IBP converter cable used for converting a Spacelabs IBP connector to two Siemens 10-Pin adapter cables. 1 foot cable.		IBP Converter Cable	<b>IC-SM2-SM1/20</b>		<b>\$154</b>
IBP converter cable used for converting a Spacelabs IBP connector to a Siemens 6-Pin adapter cable. 1 foot cable.		IBP Converter Cable	<b>IC-SM1-SM20</b>		<b>\$95</b>
IBP converter cable used for converting a Spacelabs IBP connector to a Siemens 10-Pin adapter cable. 1 foot cable.		IBP Converter Cable	<b>IC-SM2-SM10</b>		<b>\$95</b>

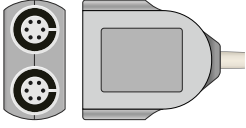
## Marquette (GE) IBP Converter

Specification	Converter	Options	Part Number	OEM #	Price
Compatible IBP converter cable used for converting a Marquette IBP connector to a standard 6-Pin adapter cable. 1 foot cable.	 	IBP Converter Cable	<b>IC-MQ-AD/20</b>	700-0028-00	<b>\$140</b>

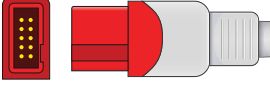
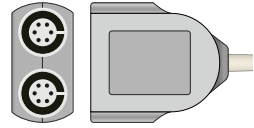

## Spacelabs IBP Converter

Specification	Converter	Options	Part Number	OEM #	Price
IBP converter cable used for converting a Spacelabs IBP connector to one standard 6-Pin adapter cable. 1 foot cable.	 	IBP Converter Cable	<b>IC-SL-AD0</b>		<b>\$129</b>
IBP converter cable used for converting a Spacelabs IBP connector to two standard 6-Pin adapter cables. 1 foot cable.	 	IBP Dual Converter Cable	<b>IC-SL-AD/20</b>	700-0028-00	<b>\$154</b>

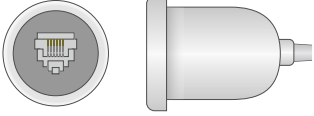
## Abbott Medex Disposable IBP Transducer

Photo	Connector	Options	Part Number	Price
		Box of 20 disposable IBP transducers	<b>IP-MX-300</b>	<b>\$322</b>

## Edwards TruWave Disposable IBP Transducer

Photo	Connector	Options	Part Number	Price
		Box of 20 disposable IBP transducers	<b>IP-ED-300</b>	<b>\$322</b>

## B. Braun Disposable IBP Transducer

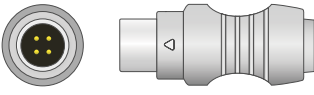
Photo	Connector	Options	Part Number	Price
		Box of 20 disposable IBP transducers	<b>IP-BB-300</b>	<b>\$322</b>

## Utah Disposable IBP Transducer

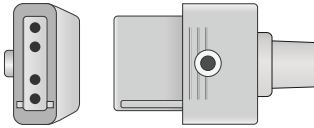
Photo	Connector	Options	Part Number	Price
		Box of 20 disposable IBP transducers	<b>IP-UT-300</b>	<b>\$322</b>

Why are we different? Because we're experts in patient monitor accessories. This is all we do and that makes us great. Call us at 866-373-6767 to talk to an expert today.

## Pressure Infusion Bags

Photo	Description	Options	Part Number	Price
	<p>Disposable, single-use pressure infusion bags reduce the risk of cross-contamination common with reusable bags. Easy to use, includes hook for hanging fluid bag, bulb to inflate bags and pressure relief valve which protects the bag from over-inflation (320mmHg pressure relief). Bag is transparent to easily view the IV bag and its fluid level. Easy bag loading and unloading, color coding allows for identification, patient customization box provides area to write patient and drug information. 0-300mmHg guage is color coded and allows for one-hand inflation. Latex free. Available in 500mL and 1,000mL options.</p>	500mL	<b>DPI-500</b>	<b>\$25</b>
		1000mL	<b>DPI-1000</b>	<b>\$29</b>

## Semi-Reusable Pressure Infusion Bags

Photo	Description	Options	Part Number	Price
	<p>Semi-reusable pressure infusion bags are more durable than disposable bags but less expensive than reusable bags. Encourages frequent disposal of bags without the expense of fully-disposable pressure infusion bags; these bags can be reused if desired. Easy to use, easy to clean, includes hook for hanging fluid bag, bulb to inflate bags and pressure relief valve which protects the bag from over-inflation (320mmHg pressure relief). Easy bag loading and unloading, color coding allows for identification, patient customization box provides area to write patient and drug information. 0-300mmHg guage is color coded and allows for one-hand inflation. Latex free. Available in 500mL and 1,000mL options in dark grey.</p>	500mL	<b>HPI-500</b>	<b>\$45</b>
		1000mL	<b>HPI-1000</b>	<b>\$49</b>

## Reusable Pressure Infusion Bags

Photo	Description	Options	Part Number	Price
	<p>Durable, reusable pressure infusion bags are easy to use, easy to clean, includes hook for hanging fluid bag, bulb to inflate bags and pressure relief valve which protects the bag from over-inflation (320mmHg pressure relief). These reusable bags are more durable than disposable infusion bags and have the benefit of a built-in bladder. The parts can be replaced as the design includes threaded connectors to easily remove and change parts. Easy bag loading and unloading, color coding allows for identification, patient customization box provides area to write patient and drug information. 0-300mmHg guage is color coded and allows for one-hand, precise inflation. Latex free. Available in 500mL and 1,000mL options in dark blue.</p>	500mL	<b>PI-500</b>	<b>\$65</b>
		1000mL	<b>PI-1000</b>	<b>\$69</b>



# Temperature

Compatible, reusable temperature probes

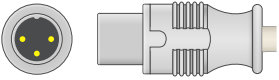

## Air Shields Reusable Temperature Probes

Models	Connector	Options	Part Number	OEM #	Price
		Adult Skin Sensor	<b>DAS-15AS0</b>		<b>\$96</b>
		Adult Rectal Sensor	<b>DAS-15AG0</b>		<b>\$96</b>

## Artema S&W Reusable Temperature Probes

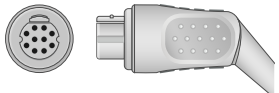
Models	Connector	Options	Part Number	OEM #	Price
		Adult Skin Sensor	<b>DSW-AS0</b>		<b>\$96</b>
		Adult Rectal Sensor	<b>DSW-AG0</b>		<b>\$96</b>

## Atom Reusable Temperature Probes

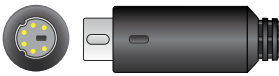
Models	Connector	Options	Part Number	OEM #	Price
Atom Medical Infant Warmer V-3200D, V-505, Infant Incubator V-2100G, V-2200, Transport Incubator V-707, V-808		Pediatric Skin Sensor	<b>DAT-15PS0</b>		<b>\$70</b>
		Pediatric Rectal Sensor	<b>DAT-15PG0</b>		<b>\$70</b>

**CAS Med** (See YSI)

**Criticare** (See YSI)

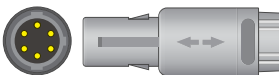

## Critikon Reusable Temperature Probes

Models	Connector	Options	Part Number	OEM #	Price
Critikon Dinamap XL and 9300 Series monitors		Oral Probe	<b>DOP-GE0010</b>	8978	<b>\$92</b>
		Rectal Probe	<b>DRP-GE-0010</b>	8976	<b>\$92</b>

## Datascope Reusable Temperature Probes (Also see YSI)

Models	Connector	Options	Part Number	OEM #	Price
Datascope Passport V		Adult Skin Sensor	<b>DDT-AS0</b>	040-000057-00	<b>\$70</b>
		Adult Rectal Sensor	<b>DDT-AG0</b>	040-000055-00	<b>\$70</b>

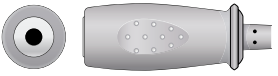
## Datascope Temperature Adapters

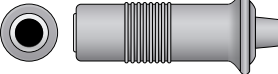

Models	Connector	Options	Part Number	OEM #	Price
For use with disposable temperature probes	To Monitor:  To Philips Mono Probe:  To GE Dual Pin Probe: 	Philips Mono Probe	<b>DDT-30-PHO</b>		<b>\$70</b>
		GE Dual Pin Probe	<b>DDT-30-ADO</b>	040-000091-00	<b>\$70</b>
For use with reusable YSI 400 temperature probes	To Monitor:  To YSI 400 Probe: 	1 Foot Cable	<b>DDT-ADO</b>		<b>\$70</b>

## Datex Ohmeda (See YSI)

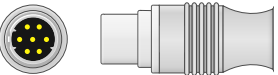
### Drager Reusable Temperature Probes (Also see YSI)

Models	Connector	Options	Part Number	OEM #	Price
Siemens Drager Infinity Vista, Delta, Gamma, Kappa		Adult Skin Sensor	<b>DSM-ASO</b>	5204669	<b>\$96</b>
		Adult Rectal Sensor	<b>DSM-AGO</b>	5204644, 5204651	<b>\$96</b>

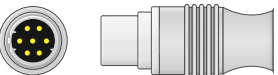
## Drager Temperature Adapters

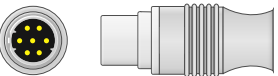
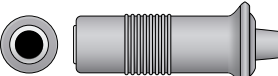
Models	Connector	Options	Part Number	OEM #	Price
For use with disposable temperature probes	To Monitor:  To Philips Mono Probe:  To GE Dual Pin Probe: 	Philips Mono Probe	<b>DSM-30-PHO</b>		<b>\$70</b>
		GE Dual Pin Probe	<b>DSM-30-ADO</b>	11-CA-407-04, 11-CA-407-12	<b>\$70</b>
For use with reusable YSI 400 temperature probes	To Monitor:  To YSI 400 Probe: 	1 Foot Cable	<b>DSM-ADO</b>	5198333	<b>\$70</b>



**Infinium** (See YSI)

**Invivo** (See YSI)

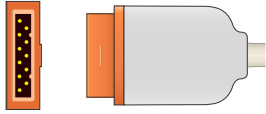

## Marquette (GE) Reusable Temperature Probes

Models	Connector	Options	Part Number	OEM #	Price
Carescape, Dash, Eagle, Tram, Solar, Mac-Lab, Cath-Lab		Adult Skin Sensor	<b>DMQ-AS0</b>		<b>\$96</b>
		Adult Rectal Sensor	<b>DMQ-AG0</b>		<b>\$96</b>
		Adult Skin Double Sensor	<b>DMQ2-AS0</b>		<b>\$96</b>

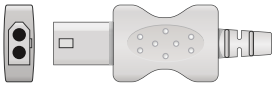
## Marquette (GE) Disposable Temperature Probes

Models	Connector	Options	Part Number	OEM #	Price
For use with temperature adapter cables		Adult/Pediatric Skin, Case of 20	<b>DMQ-D-N0</b>	8001642	<b>\$120</b>
		Adult/Pediatric Esophageal/Rectal, Case of 20	<b>DMQ-DAG-N0</b>	8001643, 8001644, V3417, ER400-9	<b>\$120</b>

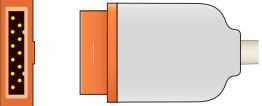

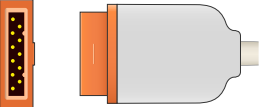
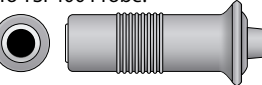
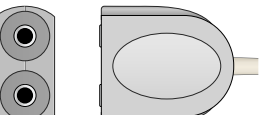
## Marquette (GE) Temperature Adapters

Models	Connector	Options	Part Number	OEM #	Price
For use with disposable temperature probes	<p>To Monitor:</p>  <p>To Philips Mono Probe:</p>  <p>To GE Dual Pin Probe:</p> 	Philips Mono Probe	<b>DMQ-30-PH0</b>	2021700-001	<b>\$70</b>
		GE Dual Pin Probe	<b>DMQ-30-AD0</b>	2021701-001	<b>\$70</b>
For use with reusable YSI 400 temperature probes. 1 foot cable	<p>To Monitor:</p>  <p>To YSI 400 Probe:</p>  <p>To DUAL 400 Probe:</p> 	Single Temp	<b>DMQ-AD0</b>	2021700-001	<b>\$70</b>
		Dual Temp YSI 400	<b>DMQ400-AD20</b>	2016998-001	<b>\$96</b>
		Dual Temp YSI 700	<b>DMQ700-AD20</b>	402015-004	<b>\$96</b>

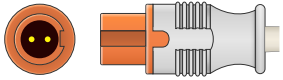
**Mindray Reusable Temperature Probes** (Also see YSI)

Models	Connector	Options	Part Number	OEM #	Price
Mindray T5, T8 and iPM-9800		Adult Skin Sensor	<b>DMR-AS0</b>	0011-30-37393	<b>\$96</b>
		Adult Rectal Sensor	<b>DMR-AGO</b>	0011-30-37382	<b>\$96</b>

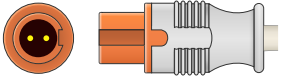
**Mindray Temperature Adapters**

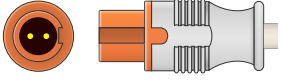
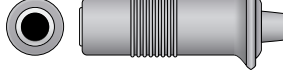
Models	Connector	Options	Part Number	OEM #	Price
For use with disposable temperature probes	To Monitor:  To Philips Mono Probe:  To GE Dual Pin Probe: 	Philips Mono Probe	<b>DMR-30-PHO</b>	011-30-37391, 0011-30-90444	<b>\$70</b>
		GE Dual Pin Probe	<b>DMR-30-ADO</b>		<b>\$70</b>
For use with reusable YSI 400 temperature probes	To Monitor:  To YSI 400 Probe: 	1 Foot Cable	<b>DMR-ADO</b>		<b>\$70</b>









**Nihon Kohden** (See YSI)**Philips Reusable Temperature Probes**

Models	Connector	Options	Part Number	OEM #	Price
For use with M1029A temperature module		Adult Skin Sensor	<b>DHP-AS0</b>	21078A	<b>\$96</b>
		Adult Rectal Sensor	<b>DHP-AGO</b>	21075A	<b>\$96</b>



**Philips Disposable Temperature Probes**

Models	Connector	Options	Part Number	OEM #	Price
For use with temperature adapter cables		Adult/Pediatric Skin, Case of 20	<b>DHP-D-N0</b>	21091A, 989803100951	<b>\$120</b>
		Adult/Pediatric Esophageal/Rectal, Case of 20	<b>DHP-DAG-N0</b>	21090A, 989803100941, M1837A, 989803105321	<b>\$120</b>

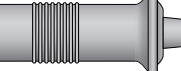







## Philips Temperature Adapters

Models	Connector	Options	Part Number	OEM #	Price
For use with disposable temperature probes	To Monitor:   To Philips Mono Probe:   To GE Dual Pin Probe:  	Philips Mono Probe	<b>DHP-30-PHO</b>	21082A, 21082B, 98980310921	<b>\$70</b>
		GE Dual Pin Probe	<b>DHP-30-ADO</b>		<b>\$70</b>
For use with reusable YSI 400 temperature probes	To Monitor:   To YSI 400 Probe:  	1 Foot Cable	<b>DHP-ADO</b>		<b>\$70</b>

## Spacelabs Reusable Temperature Probes

Models	Connector	Options	Part Number	OEM #	Price
All Spacelabs monitors including Ultraview	 	Adult Skin Sensor	<b>DSL-AS0</b>	20700-4000-00	<b>\$80</b>
		Adult Rectal Sensor	<b>DSL-AG0</b>		<b>\$80</b>
		Adult Skin Double Sensor	<b>DSL2-AS0</b>		<b>\$90</b>

## Spacelabs Temperature Adapters

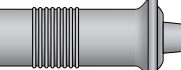

Models	Connector	Options	Part Number	OEM #	Price
For use with disposable temperature probes	To Monitor:   To Philips Mono Probe:   To GE Dual Pin Probe:  	Philips Mono Probe	<b>DSL-30-PHO</b>		<b>\$70</b>
		GE Dual Pin Probe	<b>DSL-30-ADO</b>		<b>\$70</b>
For use with reusable YSI 400 temperature probes. 1 foot cable	To Monitor:   To YSI 400 Probe:  	Single Temperature	<b>DSL-AD0</b>		<b>\$70</b>
		Dual Temperature	<b>DSL-AD20</b>	700-4000-00	<b>\$120</b>

**Welch Allyn** (See YSI)

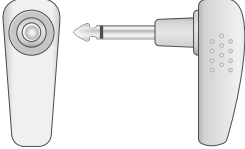
**YSI Reusable Temperature Probes**

Models	Connector	Options	Part Number	OEM #	Price
CASMed: 750; Criticare: 506, 507, 507E, 507ELC, 507S, 508, 1100, 2200, 8100 series; Datascope: Passport 2, Spectrum, Spectrum OR, Passport XG, Trio; Datex Ohmeda: S/3, CS/3, S/5, Cardiacap 1, Cardiacap 2, Cardiacap 5, Light Monitor, Satellite Plus; Dräger: Delta, Vista, Gamma, Kappa; Invivo: MDE Prism; Mindray: PM 7000, PM 8000, PM 9000 Express, PM 9000, VS-800; Nihon Kohden: BSM-2300 Life Scope I, BSM-4100 Life Scope P, BSM-5100 Life Scope A, BSM-9510 Life Scope M, BSM-9800 Life Scope S.; Welch Allyn: Atlas		Adult Skin Sensor	<b>D2252-ASO</b>	409B, 401, 709B, 701, 01-02-0326, YSI-409A, 422, 5201335, M35373, M1024254, 0206-02-0003	<b>\$70</b>
		Adult Rectal Sensor	<b>D2252-AGO</b>	420, 01-02-0327, 01-02-0379, 5201319, YSI-401, M1024247, 0206-02-0001	<b>\$70</b>
		Pediatric Skin Sensor	<b>D2252-PSO</b>		<b>\$70</b>
		Pediatric Rectal Sensor	<b>D2252-PGO</b>		<b>\$70</b>

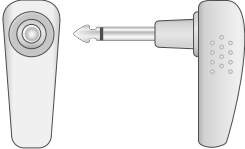
**YSI Temperature Adapters**

Models	Connector	Options	Part Number	OEM #	Price
All monitors requiring YSI temperature sensors	To Monitor:   To Philips Mono Probe:   To GE Dual Pin Probe: 	Philips Mono Probe	<b>DYSI-30-PHO</b>	989803162591	<b>\$70</b>
		GE Dual Pin Probe	<b>DYSI-30-ADO</b>	165641, 0012-00-0975, 700-4000-00, 9445-801	<b>\$70</b>



# Ultrasound Transducers

Compatible Ultrasound, Toco Transducers and Repair Cables

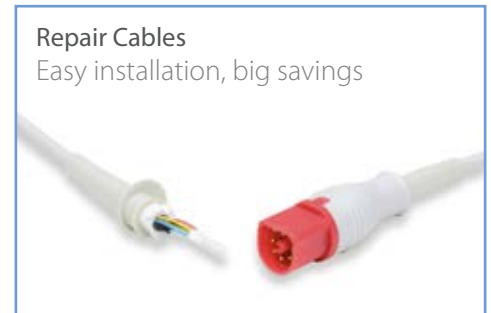
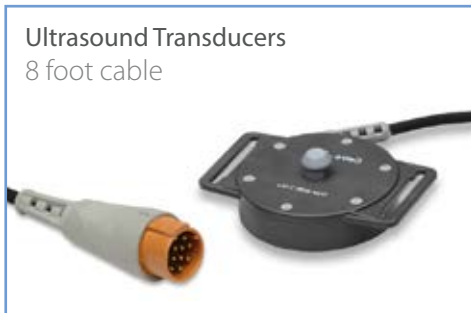

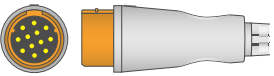
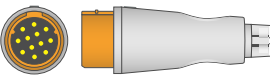
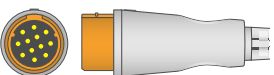

**Corometrics Ultrasound Transducer**

Models	Connector	Part Number	OEM #	Price
Corometrics Nautilus 5700LAX Corometrics 116, 118, 120, 128, 129, 145, 150, 151, 155, 170, 171, 172, 173, 174, 250, 259 and 340 monitors		<b>UFU300-100</b>	5700LAX	<b>\$286</b>
Corometrics Nautilus 5700HAX Corometrics 116, 118, 120, 128, 129, 145, 150, 151, 155, 170, 171, 172, 173, 174, 250, 259 and 340 monitors		<b>UFU300-200</b>	5700HAX	<b>\$286</b>
Corometrics Nautilus 5600AAX Corometrics 115 and 145 monitors		<b>80310170</b>	5600AAX	<b>\$286</b>

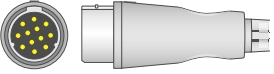
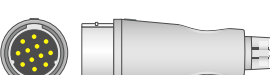

**Corometrics Toco Transducer**

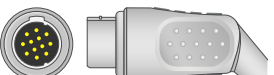
Models	Connector	Part Number	OEM #	Price
Corometrics Nautilus 2264LAX for Corometrics 116, 118, 120, 128, 129, 150, 151, 155, 170, 171, 172, 173, 174, 250, 259 and 340 monitors Corometrics 116, 118, 120, 129, 150, 151, 155, 170, 171, 250 and 340 monitors		<b>UFT300-100</b>	2264LAX	<b>\$286</b>
Corometrics Nautilus 2264HAX for Corometrics 116, 118, 120, 128, 129, 150, 151, 155, 170, 171, 172, 173, 174, 250, 259 and 340 monitors		<b>UFT300-200</b>	2264HAX	<b>\$286</b>

**Corometrics Transducer Repair Cable**

Models	Connector	Part Number	OEM #	Price
Use this compatible cable to repair the GE Corometrics 5700AAX ultrasound transducer		<b>X-US-CR20</b>		<b>\$62</b>
Use this compatible cable to repair the GE Corometrics 2264AAX toco transducer		<b>X-TC-CR10</b>		<b>\$62</b>

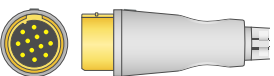
**Oxford Huntleigh Ultrasound Transducer**

Models	Connector	Part Number	OEM #	Price
Oxford Sonicaid Team Duo 1.5MHz		<b>80310400</b>	8400-6919	<b>\$258</b>
Oxford Sonicaid Team Duo 2MHz		<b>80310390</b>	8400-6920	<b>\$258</b>

### Oxford Huntleigh Toco Transducer

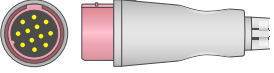
Models	Connector	Part Number	OEM #	Price
Oxford Sonicaid Team Duo		<b>80320260</b>	8400-6921	<b>\$258</b>



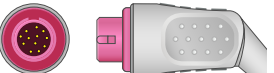
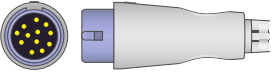

### Philips Ultrasound Transducer

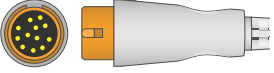
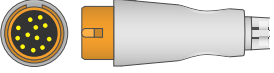
Models	Connector	Part Number	OEM #	Price
Model 1350 and Series 50 monitors		<b>UFU200-200</b>	M1356A	<b>\$258</b>
HP 8040A and 8041A monitors		<b>UFU200-100</b>	15245A	<b>\$286</b>

### Philips Toco Transducer

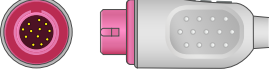
Models	Connector	Part Number	OEM #	Price
Model 1350 and Series 50 monitors		<b>UFT200-200</b>	M1355A	<b>\$286</b>
HP 8040A and 8041A monitors		<b>80320250</b>	15248A	<b>\$286</b>

### Philips Transducer Repair Cable

Models	Connector	Part Number	OEM #	Price
Use this cable to repair the Philips M1356A ultrasound transducer		<b>X-US-HP10</b>		<b>\$62</b>
Use this cable to repair the Philips M1355A toco transducer		<b>X-TC-HP10</b>		<b>\$62</b>
Use this cable to repair the Philips 15245A ultrasound transducer		<b>X-US-HP20</b>		<b>\$62</b>
Use this cable to repair the Philips 15248A toco transducer		<b>X-TC-HP20</b>		<b>\$62</b>
Use this cable to repair the Philips M2736A/ M2734A ultrasound and toco transducer		<b>X-US/TC-HP30</b>		<b>\$62</b>

## Spacelabs Ultrasound Transducer

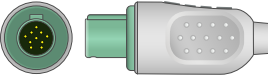
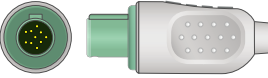
Models	Connector	Part Number	OEM #	Price
Spacelabs US91 for IM76, AM66 and Kontron monitors		<b>UFU500-200</b>	US91, AMS-20-0011	<b>\$258</b>
Spacelabs US915 for IM67 and AM77 monitors		<b>80310110</b>	US915, AMS-20-0047	<b>\$258</b>

## Spacelabs Toco Transducer

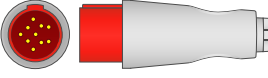
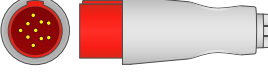
Models	Connector	Variant SKU	OEM #	Price
TD84 for IM76, AM66 and Kontron monitors		<b>80320070</b>	TD84, AMS-20-0020	<b>\$286</b>
Spacelabs TD84 for IM77 and AM67 monitors		<b>80320080</b>	TD84, AMS-20-0048	<b>\$286</b>





Oxygen Sensors  
Accurate, reliable,  
12 – 24 month  
warranties



## O<sub>2</sub> Cells

Compatible O<sub>2</sub> sensors for  
respiratory applications

**6051-0000-216 O<sub>2</sub> Cell**

Models	Warranty	Response Time	Part Number	Price
Compatible Datex Ohmeda 6051-0000-216 O <sub>2</sub> sensor for use with: City Technologies, Envitec, Nuova, Stephanie, Viamed  <ul style="list-style-type: none"> <li>• City Technologies: MOX-10</li> <li>• Envitec: OOM202-2S</li> <li>• Datex Ohmeda: 6051-0000-216</li> <li>• Nuova: E-110</li> <li>• Viamed: R-42V</li> </ul>	16 months	<12s	<b>G0-110</b>	<b>\$84</b>

**MAX-1 O<sub>2</sub> Cell**

Models	Warranty	Response Time	Part Number	Price
Compatible Maxtec MAX-1 O <sub>2</sub> sensor for use with: Datex Ohmeda Excel 210-7800, Excel 7800, Modulus 4700, Modulus 7800, Oxicap, 510, 051, 205, 125, 5100, 5120, 5125, 5140, 5125, 5200, 5250, 5250 RMG, 5400, 7200, 7800, 7810 Vent, S5172802; Envitec, Drager; Hamilton Medical; Mercury Medical MSA; Pacifitech; Teledyne #C-41131; VTI; Viamed  <ul style="list-style-type: none"> <li>• Air Shields: C-100</li> <li>• Analytical Industries: PSR-11-915</li> <li>• Biotest: S101</li> <li>• Ceramtec: CAG-1</li> <li>• City Technologies: MOX-6</li> <li>• CR: R-15</li> <li>• Datex Ohmeda: 0237-2034-700</li> <li>• Drager: 6803290</li> <li>• Envitec: OOM101</li> <li>• Hamilton: HM-10, HM-13</li> <li>• HP: 15201A</li> <li>• Hudson-RCI: 5556</li> <li>• Integral Process: 65001</li> <li>• Maxtec: MAX-1 R113P90</li> <li>• Mercury Medical: 10-103-17</li> <li>• MSA: 655264,655263</li> <li>• Nivaco: R-15</li> <li>• Nuova: E-15/0</li> <li>• Pacifitech: PT-10</li> <li>• Sensidyne: SV-14A</li> <li>• SensorTech: ST-10</li> <li>• Teledyne: R-15, #C-41131</li> <li>• Viamed: R-15</li> <li>• VTI: VT1272, 101272, 100352</li> </ul>	12 months	<17s	<b>G0-010</b>	<b>\$98</b>

## MAX-10 O<sub>2</sub> Cell

Models	Warranty	Response Time	Part Number	Price
<p>Compatible Maxtec MAX-10 O<sub>2</sub> sensor for use with: Analytical Industries; Envitec; Datex Engstrom Modulus SE7900; Datex Ohmeda Excel 210-7900, Modulus SE1700, Smart Vent, S-5, Aespire, Avance, Airsys, Aestiva 3000; Maxtec; Nuova; Teledyne; Viamed</p> <ul style="list-style-type: none"> <li>Analytical Industries: PSR-11-915-4</li> <li>Ceramatec: CAG-10</li> <li>Envitec: OOM110</li> <li>Datex Ohmeda: 6050-0004-110</li> <li>Integral Process: 65008</li> <li>Maxtec: MAX-10 R112P10</li> <li>Mercury Medical: 10-103-10</li> <li>Nuova: E-15/4</li> <li>Pacifitech: PT-20A</li> <li>Sensidyne: SV-20A</li> <li>Teledyne: R-30MED</li> <li>Ventrex: V-20A</li> <li>Viamed: R-30V</li> </ul>	16 months	<12s	<b>G0-100</b>	<b>\$95</b>

## MAX-11 O<sub>2</sub> Cell

Models	Warranty	Response Time	Part Number	Price
<p>Compatible Maxtec MAX-11 O<sub>2</sub> sensor for use with: Drager Narkomed 1A, 2, 2B, 3, 4, 6000, Babylog 8000, Savina, SA2 Anaesthesia Mach, Evita, Evita 2, Evita 4, Evita 2 Dura, Fabius, Fabius GS, Oxydig, Oxycom 100 D, PM8030, I-8000, Incubator 8000IC, Anemone; Datex Ohmeda; Envitec; Hamilton; Maxtec; Teledyne #C-61339, Viamed R-23V</p> <ul style="list-style-type: none"> <li>Analytical: PSR-11-915-2</li> <li>Drager: 6850645,6803290</li> <li>Envitec: OOM201</li> <li>Datex Ohmeda: 6051-000-224</li> <li>Hamilton: HM-14, HM-13</li> <li>Hudson-RCI: 5557, V-14</li> <li>Maxtec: MAX-11 R113P10</li> <li>MSA: 655263, 655264</li> <li>Nuova: E-15/2</li> <li>Teledyne: R-23MED</li> </ul>	12 months	<12s	<b>G0-020</b>	<b>\$98</b>

## MAX-11i O<sub>2</sub> Cell

Models	Warranty	Response Time	Part Number	Price
<p>Compatible Maxtec MAX-11i O<sub>2</sub> sensor for use with: Drager, Envitec, Maxtec, Nuova</p> <ul style="list-style-type: none"> <li>Drager: I-8000</li> <li>Envitec: OOM104</li> <li>Maxtec: MAX-11i R113P06</li> <li>Nuova: E-8000</li> </ul>	16 months	<12s	<b>G0-080</b>	<b>\$118</b>

MAX-12 O<sub>2</sub> Cell

Models	Warranty	Response Time	Part Number	Price
<p>Compatible Maxtec MAX-12 O<sub>2</sub> sensor for use with: Analytical Industries; Bird Avea Ventilator; Citi Technologies; Envitec; EME Hamilton Medical Viasys Arabella, Galileo, Raphael, Aladdin, 51254; Emerson Infant Flow; Datex Ohmeda; Hamilton Instruments Galileo, Raphael, Arabella, Multinex, Analyser; Infrasonics Adult Star 601T; Maxtec; MSA; Nuova; Puritan Bennett NP 840 Ventilator 4-074925-00; Siemens Servo 900C, 900D, 900E, Servo 300, 300A, SV 300, Servo 700, 710, SV900, V710, C/D, 9000, Infinity Delta; Spacelabs Capnograph; Taema Cesar 2, Horus; Teledyne TED 160, TED 190; and Viamed</p> <ul style="list-style-type: none"> <li>Analytical Industries: PSR-11-917-J</li> <li>Ceramatec: CAG-12</li> <li>City Technologies: MOX-9, R-24</li> <li>Envitec: OOM202</li> <li>Datex Ohmeda: 6051-0000-222</li> <li>Hamilton Medical: 396008, 396009, HM-12</li> <li>Hudson RCI: 5566, V-12</li> <li>Integral Process: 65016</li> <li>IMT Medical: PF300</li> <li>Maxtec: MAX-12 R109P45</li> <li>Mercury Medical: 10-103-06</li> <li>MSA: 472062,470644</li> <li>Nuova: E-17/M</li> <li>Pacifitech: PT-12A</li> <li>Siemens: 9004979-E347E, 6419332-E380E</li> <li>Sensidyne: SV-12A</li> <li>SensorTech: ST-01</li> <li>Spacelabs: 90513</li> <li>Taema: YR049700</li> <li>Teledyne: R24 MED, B-62321</li> <li>Ventrex: V-12A</li> <li>Viamed: R-24Med</li> <li>VTI Vascular Technology: 103100</li> </ul>	16 months	<12s	<b>G0-040</b>	<b>\$76</b>

MAX-12A O<sub>2</sub> Cell

Models	Warranty	Response Time	Part Number	Price
<p>Compatible Maxtec MAX-12A O<sub>2</sub> sensor for use with: Air Shields Isolette; Analytical Instruments; City Technologies; Criticare 8100 Poet, 8500 Poet; Envitec; Datex Ohmeda Centiva S/S; Hamilton Galileo, Raphael, Arabella, Multinex Analys; Hudson RCI; Maxtec; Nuova; Taema Cesar (new); Teledyne; Viamed</p> <ul style="list-style-type: none"> <li>Analytical Industries: PSR-11-917</li> <li>Biotest: A 103</li> <li>City Technologies: MOX-1</li> <li>Criticare: 644</li> <li>Datex Engstrom: 0600-00-0002</li> <li>Envitec: OOM102</li> <li>GE Marquette: R-22</li> <li>Hamilton Cells: HM-12</li> <li>Henleys: 5556</li> <li>Hill-Rom: R-22</li> <li>Hudson RCI: 5566, V-12</li> <li>Infrasonics: R-22</li> <li>Maxtec: MAX-12A R109P48</li> <li>Mercury Medical: 10-103-15</li> <li>Narco Med: R-22</li> <li>Nuova: E-17/A2</li> <li>Pacifitech: PT-12AIR</li> <li>SensorTech: ST-12</li> <li>Spacelabs: 90514</li> <li>Teledyne: R-22MED</li> <li>Viamed: R-22Med</li> </ul>	16 months	<12s	<b>G0-120</b>	<b>\$73</b>

## MAX-12C O<sub>2</sub> Cell

Models	Warranty	Response Time	Part Number	Price
Original Maxtec MAX-12C O <sub>2</sub> sensor for use with Viasys Avea Ventilator, Infant SiPaP • Maxtec: MAX-12C, R109P53	24 months	<6s	<b>MAX-12C</b>	<b>\$90</b>

## MAX-13 O<sub>2</sub> Cell

Models	Warranty	Response Time	Part Number	Price
Compatible Maxtec MAX-13 O <sub>2</sub> sensor for use with: Bird Products 6400, 8400, VIP Vent, Sentry; Envitec; Datex Engstrom Elvira, Erica; Datex Ohmeda; Hamilton; Hudson; Maxtec; MSA Mini-Ox I-III; Nuova; Puritan Bennett PB 850, 7820 Monitor, 7200 Ventilator; Respironics Esprit Ventilator Lifecare; Taema Eole, Cesar; Teledyne; Viamed  • Air Shields: 6735142 • Alphamed: R-17 • Analytical Instruments: PSR-11-917-J • BCI: R-17 • BioMed Devices: M-2, M-10 • Biotest: C102-1 • Bird Products: 66030 • BMD: 10006 • Ceramtec: CAG-13 • Citi Technologies: MOX-2 • Dameca: 42035-46 • Envitec: OOM103-1, OOM202-1 • Datex Ohmeda: 6051-0000-217 • Hamilton: HM-11 • Henleys: 5567 • Hudson-RCI: 5567, V-11 • Invivo: 9445 • Integral Process: 65005 • Kontron: ABT 5100 • Lifecare: PLV-100, 37-079 • Maxtec: MAX-13 R115P10 • Mercury Medical: 10-103-05 • MSA: 406931 • Nuova: E-17/J • Oxitron: 3310 • Pacifitech: PT--11A • Puritan Bennett: 4-020933-00 • Respironics: 37-079 • Sensidyne: SV-11A • SensorTech: ST-11 • Ventrex: V-14A • Viamed: R-41V • VTI: 100580	16 months	<12s	<b>G0-030</b>	<b>\$76</b>

**MAX-13C O<sub>2</sub> Cell**

Models	Warranty	Response Time	Part Number	Price
Compatible Maxtec MAX-13C O <sub>2</sub> sensor for use with: Maxtec, Nuova <ul style="list-style-type: none"> <li>• Maxtec: MAX-13C</li> <li>• Nuova: E-14/0</li> </ul>	16 months	<12s	<b>G0-140</b>	<b>\$84</b>

**MAX-14 O<sub>2</sub> Cell**

Models	Warranty	Response Time	Part Number	Price
Compatible Maxtec MAX-14 O <sub>2</sub> sensor for use with: Envitec, Maxtec, MSA Min-Ox IA, Nuova <ul style="list-style-type: none"> <li>• Ceramtec: CAG-14</li> <li>• Devilbiss: O2ANA-101</li> <li>• Envitec: OOM202-2</li> <li>• Maxtec: MAX-14 R116P80</li> <li>• Mercury Medical: 10-103-13</li> <li>• MSA: 806572</li> <li>• Nuova: E-8000</li> <li>• Pacifitech: PT-23</li> <li>• Sensidyne: SV-26</li> <li>• Ventrex: V-26</li> </ul>	16 months	<12s	<b>G0-090</b>	<b>\$78</b>

**MAX-16 O<sub>2</sub> Cell**

Models	Warranty	Response Time	Part Number	Price
Compatible Maxtec MAX-16 O <sub>2</sub> sensor for use with: Maxtec, Nuova and Covidien Puritan Bennett models 740, 760, 840; Versamed iVent 201 <ul style="list-style-type: none"> <li>- Maxtec: MAX-16 R114P70</li> <li>- Mercury Medical: 10-103-14</li> <li>- Nuova: E-16/0</li> <li>- Puritan Bennett: 4-072214-00</li> </ul>	16 months	<12s	<b>G0-160</b>	<b>\$87</b>

**MAX-17 O<sub>2</sub> Cell**

Models	Warranty	Response Time	Part Number	Price
Compatible Maxtec MAX-17 O <sub>2</sub> sensor for use with: Analytical Industries; City Technologies; Envitec; Datex Ohmeda; Hamilton; Hudson RCI; Maxtec; MSA; Nuova; Sechrist Industries 650 Ventilator 43170; Teledyne TED 60J, TED 60T, TED 191T, TED 200T, TED 200T7; Viamed <ul style="list-style-type: none"> <li>• Analytical Industries: PSR-11-77</li> <li>• Ceramtec: CAG-17</li> <li>• City Technologies: MOX-4</li> <li>• Envitec: OOM105</li> <li>• Datex Ohmeda: 6051-0000-219</li> <li>• Hamilton: HM-03</li> <li>• Hudson RCI: 5558, V-03</li> <li>• Integral Process: 65013</li> <li>• Maxtec: MAX-17 R116P10</li> <li>• Mercury Medical: 10-103-02</li> <li>• MSA: 804674</li> <li>• Newport: OM 100, VM 200</li> <li>• Nuova: E-77/0</li> <li>• Sensidyne: SV-03</li> <li>• SensorTech: ST-03</li> <li>• Teledyne: T-7</li> <li>• Ventrex: V-03</li> <li>• Viamed: T-7</li> </ul>	16 months	<8s	<b>G0-070</b>	<b>\$98</b>

## MAX-18 O<sub>2</sub> Cell

Models	Warranty	Response Time	Part Number	Price
<p>Compatible Maxtec MAX-18 O<sub>2</sub> sensor for use with: Analytical Industries, Envitec, Hudson RCI 5525, 5528, 5529, 5550, 5552; Maxtec, MSA, Nuova, Teledyne, Viamed</p> <ul style="list-style-type: none"> <li>Analytical Industries: PSR-11-33-1, PSR-11-33-2</li> <li>Ceramatec: CAG-18</li> <li>Envitec: OOM107-2</li> <li>Hudson RCI: 5569, V-02</li> <li>Integral Process: 65000</li> <li>Maxtec: MAX-18 R116P40</li> <li>Megamed: M1</li> <li>Mercury Medical: 10-103-01</li> <li>MSA: 485905, 655262</li> <li>Nuova: E-33/1</li> <li>Oxytron: 3050</li> <li>Pacifitech: PT-02</li> <li>Sensidyne: SV-02</li> <li>SensorTech: ST-02</li> <li>Teledyne: C1R, C2R</li> <li>Ventrex: V-02</li> <li>Ventronics: 5525, 5528, 5529</li> <li>Viamed: C-2R</li> </ul>	12 Months	<20s	<b>G0-060</b>	<b>\$73</b>

## MAX-19 O<sub>2</sub> Cell

Models	Warranty	Response Time	Part Number	Price
<p>Compatible Maxtec MAX-19 O<sub>2</sub> sensor for use with: Analytical Industries; Deversified Diagnostics Xenematic; Envitec; Hamilton Veolar, Amadeus, Aladdin; Heyer Pocket O<sub>2</sub>; Hudson RCI 5525, 5528, 5529, 5550, 5552; Maxtec; MSA; Nuova; Taema KV050501, Oxy 2100; Teledyne TED 160, TED 190; Viamed</p> <ul style="list-style-type: none"> <li>Analytical Industries: PSR-11-33</li> <li>Bertucci: T1, T2</li> <li>BioMed Devices: 48351</li> <li>Bio Tek: X74223</li> <li>Ceramatec: CAG-19</li> <li>Emerson: EMV-OA</li> <li>Envitec: OOM107</li> <li>Fresenius: X74223</li> <li>Hamilton: HM-01</li> <li>Henleys: 5569</li> <li>Hudson RCI: 5568, C1, V-01</li> <li>Imed: 810, 825</li> <li>Inmed: T-1, T-2</li> <li>Integral Process: 65007</li> <li>Ivac: 1200, 1225</li> <li>Libra: OM500</li> <li>Maxtec: MAX-19 R116P60</li> <li>Medigas: T-1, T-2</li> <li>Megamed: M2</li> <li>Mercury Medical: 10-103-00</li> <li>MSA: 478841, 485955</li> <li>Nuova: E-33/0</li> <li>Oxitron: 3250</li> <li>Pacifitech: PT-01</li> <li>Sensidyne: SV-01</li> <li>SensorTech: ST-01</li> <li>Taema: KV050501</li> <li>Teledyne: T1, T2</li> <li>Toptronic: XT74223</li> <li>Ventrex: V-01</li> <li>Viamed: T-1, T-2</li> <li>Vickers: 251</li> </ul>	12 Months	<20s	<b>G0-050</b>	<b>\$73</b>

**MAX-2 O<sub>2</sub> Cell**

Models	Warranty	Response Time	Part Number	Price
<p>Original Maxtec MAX-2 O<sub>2</sub> sensor for use with Analytical Industries; Drager Narkomed Series, Fabius GS, Fabius, GS, Tiro, 6850645, 6803290; Philips HP; Invivo: Magnitude; Mercury Medical; Pacifitech; Teledyne; VTI.</p> <ul style="list-style-type: none"> <li>Analytical Industries: PSR-11-915-1</li> <li>Drager: 6850645, 6803290</li> <li>HP: 15201A</li> <li>Maxtec: MAX-2, R107P20</li> <li>Mercury Medical: 10-103-12</li> <li>Pacifitech: PT-24</li> <li>Teledyne: R31</li> <li>VTI: 101372</li> </ul>	24 months	<15s	<b>MAX-2</b>	<b>\$190</b>

**MAX-250 O<sub>2</sub> Cell**

Models	Warranty	Response Time	Part Number	Price
<p>Original Maxtec MAX-250 O<sub>2</sub> sensor for use with Maxtec OM-25A; Mercury Medical; Pacifitech; Teledyne</p> <ul style="list-style-type: none"> <li>Maxtec: MAX-250, R125P01-002</li> <li>Mercury Medical: 10-103-11</li> <li>Pacifitech: PT-250</li> <li>Teledyne: R29</li> </ul>	24 months	<15s	<b>MAX-250</b>	<b>\$110</b>

**MAX-250E O<sub>2</sub> Cell**

Models	Warranty	Response Time	Part Number	Price
<p>Original Maxtec MAX-250E O<sub>2</sub> sensor for use with Maxtec MaxO2+AE, OM-25AE, OM-25ME, MaxBlend, MaxVenturi; Analytical Industries; CareFusion Cardinal, Viasys; Sentry Blender; Fluke VT Mobile; Mercury Medical; Newport Medical e360 and e500 vents; Pacifitech; Teledyne; Viasys Sentry Blender, 66045</p> <ul style="list-style-type: none"> <li>Analytical Industries: PSR-11-917-J1</li> <li>Maxtec: MAX-250E, R125P03-002</li> <li>Mercury Medical: 10-103-08</li> <li>Pacifitech: PT-25A</li> <li>Teledyne: R29MED/#C-70592</li> <li>Viasys: 66045</li> </ul>	24 months	<15s	<b>MAX-250E</b>	<b>\$110</b>

**MAX-250ESF O<sub>2</sub> Cell**

Models	Warranty	Response Time	Part Number	Price
<p>Compatible Maxtec MAX-250ESF O<sub>2</sub> sensor for use with: Analytical Industries, Maxtec, Nuova</p> <ul style="list-style-type: none"> <li>Analytical Industries: PSR-11-917-J1</li> <li>Maxtec: MAX-250ESF R115P85</li> <li>Mercury Medical: 10-103-08</li> <li>Nuova: E-25/0</li> <li>Pacifitech: PT-25A</li> <li>Sensidyne: SV-25A</li> </ul>	16 months	<12s	<b>G0-250</b>	<b>\$106</b>



## MAX-3 O<sub>2</sub> Cell

Models	Warranty	Response Time	Part Number	Price
Compatible Maxtec MAX-3 O <sub>2</sub> sensor for use with: City Technologies; Maxtec; Nuova and Penlon Prisma SP2  <ul style="list-style-type: none"> <li>• City Technologies: MOX-3</li> <li>• Maxtec: MAX-3 R109P11</li> <li>• Nuova: E-77/05</li> </ul>	12 months	<15s	<b>G0-0750</b>	<b>\$98</b>

## MAX-43 O<sub>2</sub> Cell

Models	Warranty	Response Time	Part Number	Price
Compatible Maxtec MAX-43 O <sub>2</sub> sensor for use with: Datex Ohmeda Giraffe, Maxtec, Nuova  <ul style="list-style-type: none"> <li>• Maxtec: MAX-43 R109P07</li> <li>• Mercury Medical: 10-103-16</li> <li>• Nuova: E-43/0</li> <li>• GE: 6600-1278-600</li> </ul>	12 months	<17s	<b>G0-430</b>	<b>\$132</b>

## MAX-47 O<sub>2</sub> Cell

Models	Warranty	Response Time	Part Number	Price
Compatible Maxtec MAX-47 O <sub>2</sub> sensor for use with: Maxtec, Nuova; Hudson 5801  <ul style="list-style-type: none"> <li>• Hudson RCI: 5803</li> <li>• Maxtec: MAX-47</li> <li>• Mercury Medical: 10-103-20</li> <li>• Nuova: E-47/0</li> </ul>	12 months	<12s	<b>G0-470</b>	<b>\$78</b>

## MAX-48 O<sub>2</sub> Cell

Models	Warranty	Response Time	Part Number	Price
Compatible Maxtec MAX-48 O <sub>2</sub> sensor for use with: Analytical Industries, Maxtec, Nuova  <ul style="list-style-type: none"> <li>• Analytical Industries: M-11-60</li> <li>• Maxtec: MAX-48</li> <li>• Nuova: E-60</li> </ul>	12 months	<12s	<b>G0-480</b>	<b>\$78</b>

## MAX-7 O<sub>2</sub> Cell

Models	Warranty	Response Time	Part Number	Price
Compatible Maxtec MAX-7 O <sub>2</sub> sensor for use with: Analytical Industries; City Technologies; Envitec OxiQuant M; Maxtec; MSA Mini-OX3000; Nuova; Siare Morpheus; Taema Alys, Clarys, YR010100; Stephan Artec; Teledyne TED AX 300; Viamed  <ul style="list-style-type: none"> <li>• Analytical Industries: PSR-11-917J</li> <li>• Atom: OX-60</li> <li>• City Technologies: MOX-2</li> <li>• Datascope: 0600-00-0106</li> <li>• Envitec: OOM102-1</li> <li>• Maxtec: MAX-7</li> <li>• Mercury Medical: 10-103-18</li> <li>• Nuova: E-15/5</li> <li>• Pacifitech: PT-11A</li> <li>• Spacelabs: 015-0285-00</li> <li>• Teledyne Cells: C43690 R-17MED</li> <li>• Viamed: R-26Med</li> </ul>	16 months	<12s	<b>G0-150</b>	<b>\$73</b>

**MAX-8 O<sub>2</sub> Cell**

Models	Warranty	Response Time	Part Number	Price
Original Maxtec MAX-28 O <sub>2</sub> sensor for use with Analytical Industries; GE (Datex Ohmeda) Excel Modulus, 5250 (ext. only), 5100, 5150, 5120/5125; Mercury Medical; Teledyne; VTI  <ul style="list-style-type: none"> <li>• Analytical Industries: PSR-11-915-3</li> <li>• GE Datex Ohmeda: 0237-2034-700</li> <li>• Maxtec: MAX-8, R107P22</li> <li>• Mercury Medical: 10-103-13</li> <li>• Teledyne: R32MED, #B-73463</li> <li>• VTI: 101272</li> </ul>	24 months	<15s	<b>MAX-8</b>	<b>\$190</b>

**MAX-9 O<sub>2</sub> Cell**

Models	Warranty	Response Time	Part Number	Price
Compatible Maxtec MAX-9 O <sub>2</sub> sensor for use with: Analytical Instruments; Hudson RCI 6477, 5577, 5584, 5590, 5595; Maxtec; MSA; Nuova; Teledyne #B 39636; Viamed  <ul style="list-style-type: none"> <li>• Air Shields: 6736140</li> <li>• Analytical Industries: PSR-11-55</li> <li>• Ceramatec: CAG-9</li> <li>• Hudson RCI: 5500, V-05</li> <li>• Integral Process: 65003</li> <li>• Maxtec: MAX-9 R114R80</li> <li>• Mercury Medical: 10-103-03</li> <li>• MSA: 655265</li> <li>• Nuova: E-55/0</li> <li>• Oxitron: 3110</li> <li>• Pacifitech: PT-05</li> <li>• SensorTech: ST-05</li> <li>• Teledyne: R-13</li> <li>• Ventronics: 5500, 5570, 5575, 5584, 5590, 5595</li> <li>• Viamed: R-13</li> </ul>	12 months	<15s	<b>G0-130</b>	<b>\$90</b>

## Warranty Information:

We guarantee that our products will work at the best of their ability, free of any manufacturing defects within the following warranty periods:

Product Category	Warranty Period
All SpO2 Products	1 full year
ECG and EKG Products	6 months
NIBP Hoses & Cuffs	6 months
Temperature Probes	6 months
IBP Products	1 full year
Toco & Ultrasound Transducers	1 full year
O2 Sensors	12 – 16 months depending on model

## Fanatical Warranty™

We are fanatical about the quality of our products. We also understand just how critical patient monitoring is for saving lives. For this reason we launched our Fanatical Warranty™ service. If any of our products fail due to manufacturing defects during the product's warranty period, we will replace it, no questions asked, free of charge, and overnight.



## Why us?

### Fast shipping:

98% of all orders ship same day from our warehouse in Florida

### Same-day turnaround:

All orders before 5PM EST ship the same day

### We're experts:

Our focus allows us to know patient monitor accessories like no one else

### One-stop shop:

We outfit your entire monitor, any brand under the sun

### Cross reference:

Search by OEM part number on our powerful, easy-to-use website. Get access to thousands of high-quality images for all our parts

### We're different:

No restocking fees, easy returns, no red tape, if you don't love our products, we'll take them back

### We'll drop ship:

We'll ship to your customer on your behalf at no extra charge

Abbott®, Bionet®, Burdick®, Datascope®, Passport®, GE®, Datex-Ohmeda®, TruStat®, TuffStat®, Oxytip+®, Criticare®, Poet®, nGenuity®, Colin®, Corometrics®, Edan®, Edwards®, TruWave®, Fukuda Denshi®, ApexPro®, Multi-Link®, Invivo®, Kenz®, Kontron®, Masimo®, LNCS®, LNOP®, Marquette®, Medtronic®, Mennen Medical®, Mindray®, Nellcor®, OxilMax®, Nihon Kohden®, Life Scope®, Cardioline®, Nonin®, Novamatrix®, Philips®, IntelliVue®, Physio-Control®, Lifepak®, Respiration Inc., Artema®, Schiller®, Siemens®, Dräger®, Infinity®, Delta®, MultiMed®, Spacelabs®, and Welch Allyn® are registered trademarks of their respective owners. Use thereof does not imply any endorsement or certification by their respective owners or any affiliation with Cables and Sensors, LLC. Please note that the accessories listed in this catalog are compatible alternatives to OEM products.

All contents © copyright Cables and Sensors, LLC. All rights reserved.

Use and/or duplication of this catalog's content or images without express and written permission from Cables and Sensors, LLC is strictly prohibited.

Proudly printed in the USA.

CABLES  
AND  
SENSORS

866-373-6767 • [www.CablesandSensors.com](http://www.CablesandSensors.com)

SAME-DAY Shipping! Order by 5PM EST 

